

PSH030 Exploded View

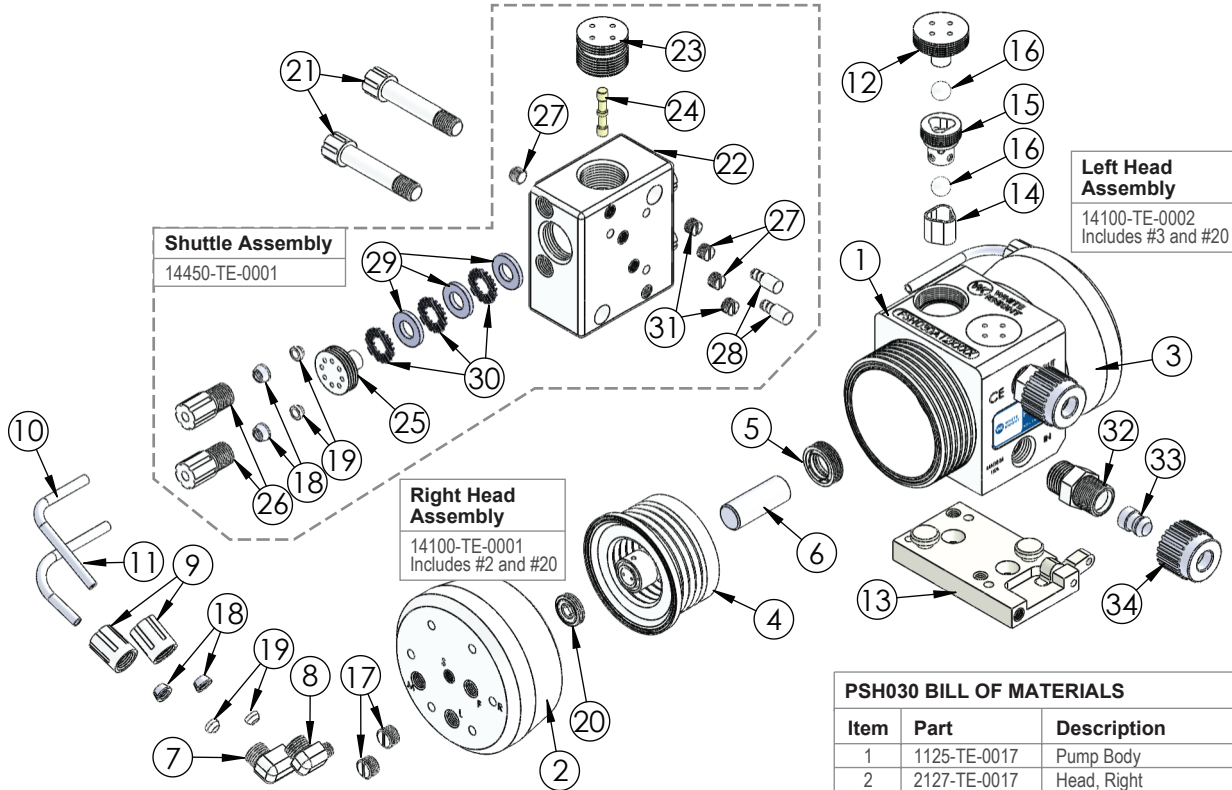

PSH030 BILL OF MATERIALS

Item	Part	Description	Qty
1	1125-TE-0017	Pump Body	1
2	2127-TE-0017	Head, Right	1
3	2127-TE-0018	Head, Left	1
4	14300-MP-0013	Bellows, Assembly	2
5	5143-MP-0001	Seal, Shaft	2
6	5144-PF-0024	Shaft	1
7	6030-TE-0004	Elbow, Gripper, 1/4" NPT x 1/4"	2
8	6030-TE-0001	Elbow, Gripper, 1/8" NPT x 1/4"	2
9	6070-TE-0001	Female Gripper Nut, 1/4"	4
10	10071-PF-0009	Tubing, 1/4"	2
11	10071-PF-0008	Tubing, Thick Wall, 1/4"	2
12	4140-TE-0001	Top Check Plug	2
13	14200-NP-0006	Plate, Base, Assembly	1
14	4135-MP-0006	Seat, Check	2
15	4142-MP-0004	Cage, Check	2
16	4100-MP-0004	Ball, Check, 1/2"	4
17	10040-TE-0003	Plug, NPT, 1/4"	4
18	6080-KF-0001	Gripper, 1/4"	8
19	6080-TE-0001	Ferrule, 1/4"	8
20	3133-TE-0006	Seat, Head, Shift	2
21	10010-TE-0017	Screw, Mount, Shuttle	2
22	14400-TE-0009	Body, Shuttle, With Sleeve	1
23	6530-TE-0001	Shuttle End Cap	2
24	6560-CE-0001	Shuttle Spool	1
25	6150-TE-0010	Cap, Muffler	2
26	6070-TE-0004	Male Gripper Nut, 1/4"	4
27	10040-TE-0002	Plug, Npt, 1/8"	3
28	10020-TE-0004	Pin, Alignment, Shuttle	2
29	6140-FP-0003	Baffle	6
30	6140-PP-0003	Spacer, Baffle	6
31	10040-TE-0015	Plug, Vent, NPT, 1/8"	2
32	7400-TE-0001	Body, S-300®, 1/2"	2
33	7400-PF-0001	Insert, S-300®, 1/2"	2
34	7400-PF-0005	Nut, S-300®, 1/2"	2

Leak Detect	
Part	Description
14600-XX-0009	LF0 15 ft fiber optic cable with no amplifier
14600-XX-0010	LF1 15 ft fiber optic cable with D10 amplifier
14600-XX-0011	LF2 25 ft fiber optic cable with no amplifier
14600-XX-0012	LF3 25 ft fiber optic cable with D10 amplifier
14600-XX-0031	LC0 15 ft conductivity cable
14600-XX-0040	LC1 25 ft conductivity cable

Stroke Detect with Fiber Optics	
Part	Description
14700-XX-0017	SF0 15 ft fiber optic cable with no amplifier
14700-XX-0018	SF1 15 ft fiber optic cable with D10 amplifier
14700-XX-0019	SF2 25 ft fiber optic cable with no amplifier
14700-XX-0020	SF3 25 ft fiber optic cable with D10 amplifier

Stroke Detect with Pressure Switch	
Part	Description
14900-NP-0004	SP1 Single NPN Switch
14900-NP-0003	SP2 Dual NPN Switches
14900-NP-0001	SP4 Single PNP Switch
14900-NP-0002	SP5 Dual PNP Switches

Fittings (Type, Size, Option)	Assemblies	Body Inlet Only (Nut not included)
Flaretek Compatible	1/4 in. F04	14510-PF-0016 7200-PF-0001
	3/8 in. F06	14510-PF-0001 7200-PF-0002
	1/2 in. F08	14510-PF-0002 7200-PF-0003
	3/4 in. F12	14510-PF-0003 7200-PF-0004
Tube Out	3/8 in. T06	7120-PF-0001
	1/2 in. T08	7120-PF-0002
	3/4 in. T12	7120-PF-0003
Weldable	1/2 in. W08	7300-PF-0001
	3/4 in. W12	7300-PF-0002
Pillar S-300	1/4 in. P04	14530-PF-0025 7400-TE-0031
	3/8 in. P06	14530-PF-0012 7400-TE-0023
	1/2 in. P08	14530-PF-0001 7400-TE-0001
	3/4 in. P12	14530-PF-0002 7400-TE-0002
FNPT	1/4 in. N04	7100-TE-0001
	3/8 in. N06	7100-TE-0002
	1/2 in. N08	7100-TE-0003
	3/4 in. N12	7100-TE-0007
Synchro-Flare	3/8 in. S06	14520-TE-0009 7010-TE-0001
	1/2 in. S08	14520-TE-0001 7010-TE-0003
	3/4 in. S12	14520-TE-0002 7010-TE-0002
PrimeLock	1/4 in. L04	14570-PF-0013 7800-TE-0013
	3/8 in. L06	14570-PF-0014 7800-TE-0014
	1/2 in. L08	14570-PF-0001 7800-TE-0001
	3/4 in. L12	14570-PF-0002 7800-TE-0002
Plugged	B00	7130-TE-0001

<https://wkfluidhandling.com/psH-series/>