

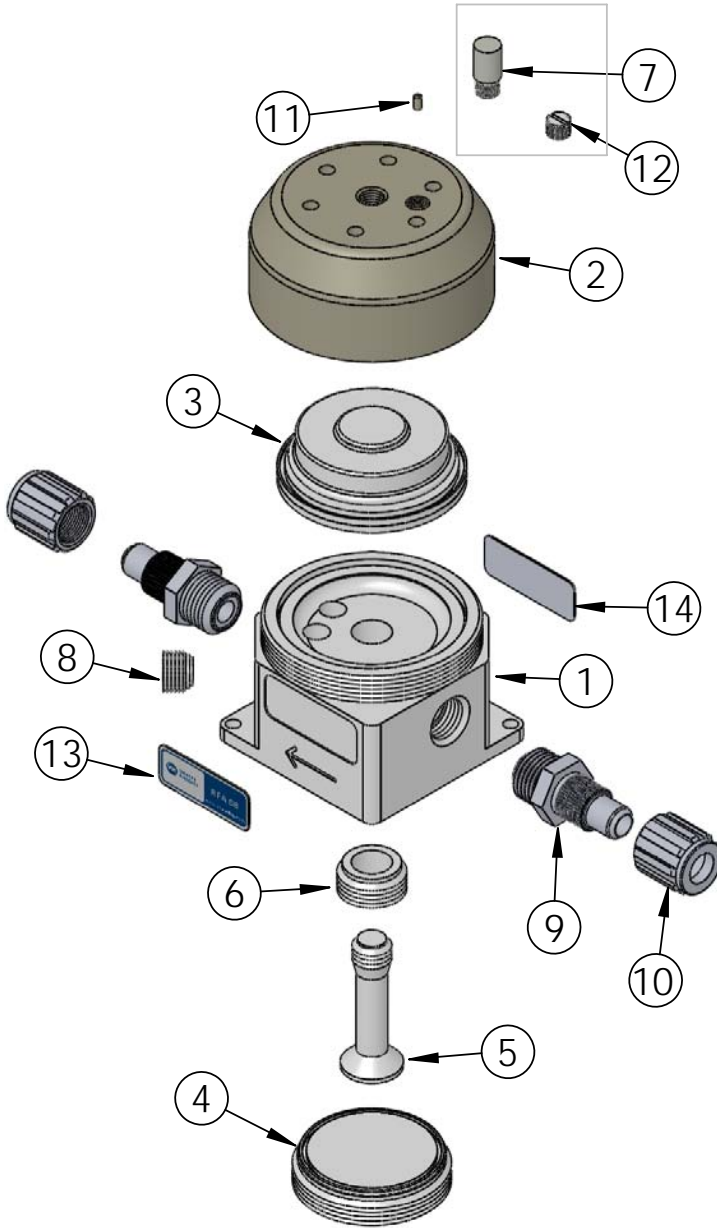







RFA08PO Exploded View

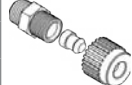

Item	Part Number	Description	Qty.
1	1150-TE-0006	Body	1
2	2150-EP-0003	Head	1
3	3130-MP-0038	Bellows	1
4	4139-TE-0009	Plug	1
5	4143-TE-0006	Piston-poppet	1
6	4144-TE-0001	Seat, Poppet	1
7	6110-PP-0003	Poly Pro Muffler 1/8"	1
8	7130-TE-0006	Plug, Fluid Port, 1/4"	1
9	7200-PF-0003	Body, Flaretek®, 1/2"	2
10	7210-PF-0003	Nut, Flaretek®, 1/2"	2
11	10020-PK-0002	Restrictor, .016 Orifice	1
12	10040-TE-0002	1/8" NPT Plug	1
13	19100-PP-0048	Product Label	1
14	19100-PP-0059	CE Sticker	1

Fittings (Type, Size, Option)			Assemblies	Body Inlet Only (Nut not included)
 Flaretek Compatible	1/4 in.	F04	14510-PF-0016	7200-PF-0001
	3/8 in.	F06	14510-PF-0001	7200-PF-0002
	1/2 in.	F08	14510-PF-0002	7200-PF-0003
	3/4 in.	F12	14510-PF-0003	7200-PF-0004
 Tube Out	3/8 in.	T06	7120-PF-0001	
	1/2 in.	T08	7120-PF-0002	
	3/4 in.	T12	7120-PF-0003	
 Weldable	1/2 in.	W08	7300-PF-0001	
	3/4 in.	W12	7300-PF-0002	
 Pillar S-300	1/8 in.	P02	TBD	7400-TE-0036
	1/4 in.	P04	14530-PF-0025	7400-TE-0031
	3/8 in.	P06	14530-PF-0012	7400-TE-0023
	1/2 in.	P08	14530-PF-0001	7400-TE-0001
	3/4 in.	P12	14530-PF-0002	7400-TE-0002
 FNPT	1/4 in.	N04	7100-TE-0001	
	3/8 in.	N06	7100-TE-0002	
	1/2 in.	N08	7100-TE-0003	
	3/4 in.	N12	7100-TE-0007	
 Synchro-Flare	3/8 in.	S06	14520-TE-0009	7010-TE-0001
	1/2 in.	S08	14520-TE-0001	7010-TE-0003
	3/4 in.	S12	14520-TE-0002	7010-TE-0002
 PrimeLock	1/4 in.	L04	14570-PF-0013	7800-TE-0013
	3/8 in.	L06	14570-PF-0014	7800-TE-0014
	1/2 in.	L08	14570-PF-0001	7800-TE-0001
	3/4 in.	L12	14570-PF-0002	7800-TE-0002
Plugged		B00	7130-TE-0001	

<https://wkfluidhandling.com/pressure-regulators/>