

TYTAN™

Inline Water Heater

Instruction Manual



www.processtechnology.com

7010 Lindsay Dr., Mentor, OH 44060 Phone: 440-974-1300 Fax: 440-974-9561 USA/CN: 800-621-1998

TABLE OF CONTENTS:

RELATED DOCUMENTS	3
INTRODUCTION	4
SYSTEM SPECIFICATIONS	6
MODEL NUMBER	10
MODEL NUMBER EXPLANATION.....	11
FACILITY REQUIREMENTS	13
WATER PLUMBING REQUIREMENTS	14
ELECTRICAL REQUIREMENTS	14
INSTALLATION	15
INSPECTION AND UNCRATING	15
POSITIONING AND MOUNTING	17
PLUMBING.....	19
WIRING	21
RC1, RC2 COMMUNICATIONS (OPTIONAL).....	23
RC3 COMMUNICATIONS (OPTIONAL).....	24
MA PROCESS OUTPUT (OPTIONAL).....	24
RC3 PLUS MA COMMUNICATIONS (OPTIONAL).....	25
RI REMOTE INTERFACE (OPTIONAL).....	25
OPERATIONS	27
CONTROL PANEL	27
TEMPERATURE CONTROLLER E5CN.....	29
PARAMETER SETTINGS E5CN.....	31
CHANGING SET POINT E5CN.....	31
HIGH ALARM E5CN.....	32
PID TUNING E5CN	32
TEMPERATURE CONTROLLER E5CK (RC OPTIONS).....	33
PARAMETER SETTINGS E5CN.....	35
CHANGING SET POINT E5CN.....	35
HIGH ALARM E5CN.....	36
PID TUNING E5CN	36
PARAMETER SETTINGS E5CK.....	39
CHANGING SET POINT E5CN.....	39
HIGH ALARM E5CN.....	40
PID TUNING E5CN	40
OVER TEMPERATURE CONTROLLER: FDC-L91	41
SYSTEM START UP.....	44
SYSTEM SHUT DOWN	44
SPARE PARTS	45
MAINTENANCE	46
TROUBLESHOOTING	47
WARRANTY	49

RELATED DOCUMENTS:

The following documents are to be used in conjunction with this manual:

ANSI/NFPA70 – National Electric Code[→], latest edition. To be used to determine appropriate electrical service, wire sizing, routing and protection.

SEMI S2 – Semiconductor Equipment Safety Guidelines, latest edition. To be used in conjunction with safe operation, access and decommissioning procedures.

OMRON E5CN INSTRUCTION MANUAL – To be used to access features of the E5CN temperature controller. (Secure appropriate manual for any optional temperature controller used in place of the E5CN).

OMRON E5CN-H INSTRUCTION MANUAL (for units with RC2 or MA option) – To be used to access features of the E5CN-H temperature controller.

OMRON E5EN-H INSTRUCTION MANUAL (for units with RC3 option) – To be used to access features of the E5EN-H temperature controller.

ANY – State or local building codes that would cover the electrical, mechanical, or physical installation of electrical heating equipment.

National Electric Code[→]
NFPA 1999 Copyright
National Fire Protection Association
Quincy, Mass. 02269

INTRODUCTION:

The following symbols and warning labels appear on the unit and in the instruction manual. The table below provides an explanation of each one.











DESCRIPTION	PICTORAL DESCRIPTION	DESCRIPTION
DANGER indique une situation dangereuse imminente qui mènera à un décès ou des blessures graves si elle n'est pas évitée. Ce mot clé sera limité aux situations les plus extrêmes.		DANGER indicates an imminently hazardous situation which, if not avoided, will result in death or serious injury. This signal word is to be limited to the most extreme situations.
WARNING indique une situation dangereuse imminente qui mènera à un décès ou des blessures graves si elle n'est pas évitée.		WARNING indicates a potentially hazardous situation which, if not avoided, could result in death or serious injury.
ATTENTION indique une situation potentiellement dangereuse qui pourrait mener à blessure bénigne ou modérée. ATTENTION peut également être utilisé pour avertir les pratiques dangereux.		CAUTION indicates a potentially hazardous situation which, if not avoided, may result in minor or moderate injury. It may also be used to alert against unsafe practices.
DANGER: TENSION DANGEREUSE CI-JOINTE Tension ou danger de courant suffisant pour causer choc, brûlure, ou mort. Couper le courant et mettre une déconsignation avant de réparer.	 	DANGER: HAZARDOUS VOLTAGE ENCLOSED Voltage or current hazard sufficient to cause shock, burn or death. Disconnect and lock out power before servicing.
ATTENTION: TENSION DANGEREUSE Toucher peut causer un choc électrique ou une brûlure. Cette machine devrait être réparée uniquement par personnel qualifié.	 	WARNING: HAZARDOUS VOLTAGE Contact may cause electric shock or burn. This unit to be serviced by trained personnel only
ATTENTION: SURFACE CHAUDE. NE PAS TOUCHER. La colonne du peut être chaude. Laisser refroidir avant l'entretien.	 	CAUTION: HOT SURFACE. DO NOT TOUCH Heater column may be hot. Allow unit to cool before servicing.
MISE À TERRE		PROTECTIVE EARTH (GROUND)

Table 1: TYTAN Warning Labels

INTRODUCTION (Continued):

The TYTAN water heater is designed for inline heating of de-ionized (DI) water, city water, reverse-osmosis (RO) water, and filtered seawater. It can perform both as a recirculating heater or a single-pass heater.

TEMPERATURE PERFORMANCE: The TYTAN water heater is designed to provide a specified temperature increase at a given flow rate. Table 2 shows the maximum temperature increase (ΔT) that can be achieved for continuous flow conditions at the specific heater power ratings varying from 12 kW to 144 kW (Higher wattage systems available upon request). The temperature control system provided with the heater will modulate the power to the heating columns in order to maintain your specific outlet temperature setting.

	Heater Power (Kilowatts)								
Flow Rate	12	18	24	36	48	72	96	120	144
GPM	Maximum Theoretical Temperature Rise (°F)								
1	80.8	121.2	-	-	-	-	-	-	-
2	40.4	60.6	80.8	121.2	-	-	-	-	-
4	20.2	30.3	40.4	60.6	80.8	121.1	-	-	-
6	13.5	20.2	26.9	40.4	53.8	80.8	107.7	134.6	-
8	10.1	15.1	20.2	30.3	40.4	60.6	80.8	101.0	121.2
10	8.0	12.1	16.1	24.2	32.3	48.4	64.6	80.8	96.9
12	6.7	10.1	13.4	20.2	26.9	40.4	53.8	67.3	80.8
14	5.7	8.6	11.5	17.3	23.0	34.6	46.1	57.7	69.2
16	5.0	7.5	10.1	15.1	20.2	30.3	40.4	50.5	60.6
18	4.5	6.7	8.9	13.4	17.9	26.9	35.9	44.8	53.8
20	4.0	6.0	8.0	12.1	16.1	24.2	32.3	40.4	48.4
22	3.6	5.5	7.3	11.0	14.6	22.0	29.3	36.7	44.0
24	3.3	5.0	6.7	10.1	13.4	20.2	26.9	33.6	40.4

Table 2: Maximum Temperature Rise

SAFETY DEVICES: The TYTAN water heaters include a comprehensive system of safety controls and devices to insure safe and long-lasting operation. The list of safeties is included in *Table 3: System Specifications* provided on the following page.

SYSTEM SPECIFICATIONS:

Product	TYTAN inline titanium water heater			
Standards	UL, cUL standard (up to 480V) CE, SEMI S3 optional (-SC)			
Available Wattage Range	9kW – 144kW Refer to model number label for the wattage of any specific unit			
Available Voltages	208V – 600V, 50/60Hz, 3 phase standard (Some voltages available in single phase or with special construction, consult factory for details)			
Cabinet dimensions:	Width	Depth	Height	Weight
12kW – 48kW	28.5-in (75 cm)	13.5-in (34 cm)	36-in (91 cm)	145 lbs. (66 kg)
72kW	37.5-in (95 cm)	13.5-in (34 cm)	36-in (91 cm)	230 lbs. (104 kg)
96kW – 144kW	28-in (71 cm)	17-in (43 cm)	63-in (160 cm)	300 lbs. (136 kg)
Wetted surfaces:				
Heating elements	CP2 titanium standard, (316SS optional [-S option])			
Columns and plumbing	CP2 titanium standard, (316SS optional [-S option])			
PRV Valve	PVDF			
Operating temperatures:				
Process inlet				
Process outlet	Up to 194°F (90°C), depending upon operating conditions			
Temperature accuracy	+/- 1°F, depending upon operating conditions			
Ambient air temperature	86°F (30°C) maximum			
Water pressure range	Minimum 10 psi (69 kPa, 0.69 bar) Maximum 100 psi (690 kPa, 6.9 bar)			
Minimum water flow rate:				
9kW - 24kW	0.5 gpm (2 lpm)			
36kW – 48kW	1.0 gpm (4 lpm)			
72 kW	1.5 gpm (6 lpm)			
96kW	2.0 gpm (8 lpm)			
120kW	2.5 gpm (10 lpm)			
144kW	3.0 gpm (12 lpm)			
Standard Safety Devices:	EMO Pushbutton Pressure Relief Valve (PRV), connected to inlet manifold Electrically grounded heating chamber construction Ground Fault Protection (GFP) Safety Limit Control (SLC) Bimetallic heater over temperature sensor(s) Heater outlet overtemperature alarm Solid state relay (SSR) overheat bimetallic sensor Sensor failure detection Control circuit fuse protection			

Table 3: TYTAN Specifications

SYSTEM SPECIFICATIONS (Continued):

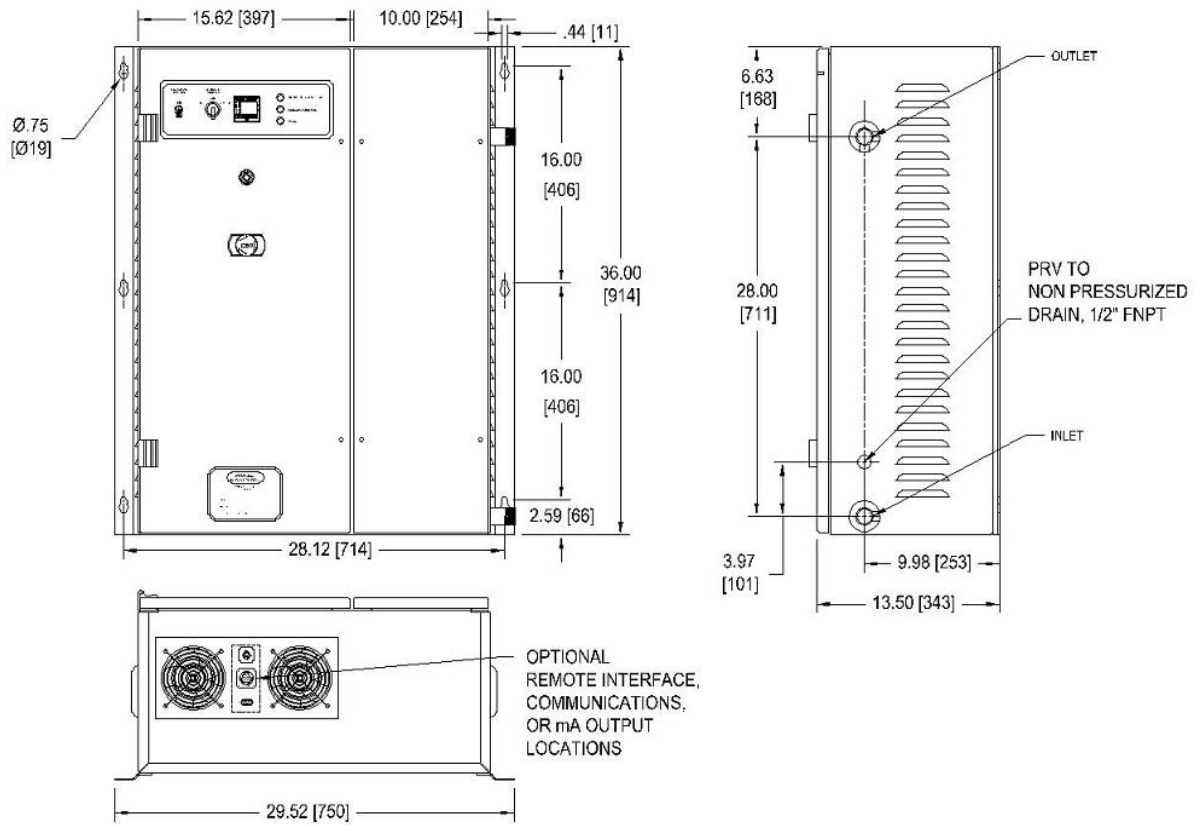

Figure 1: Dimensional Drawing, 12kW – 48kW Units

SYSTEM SPECIFICATIONS (Continued):

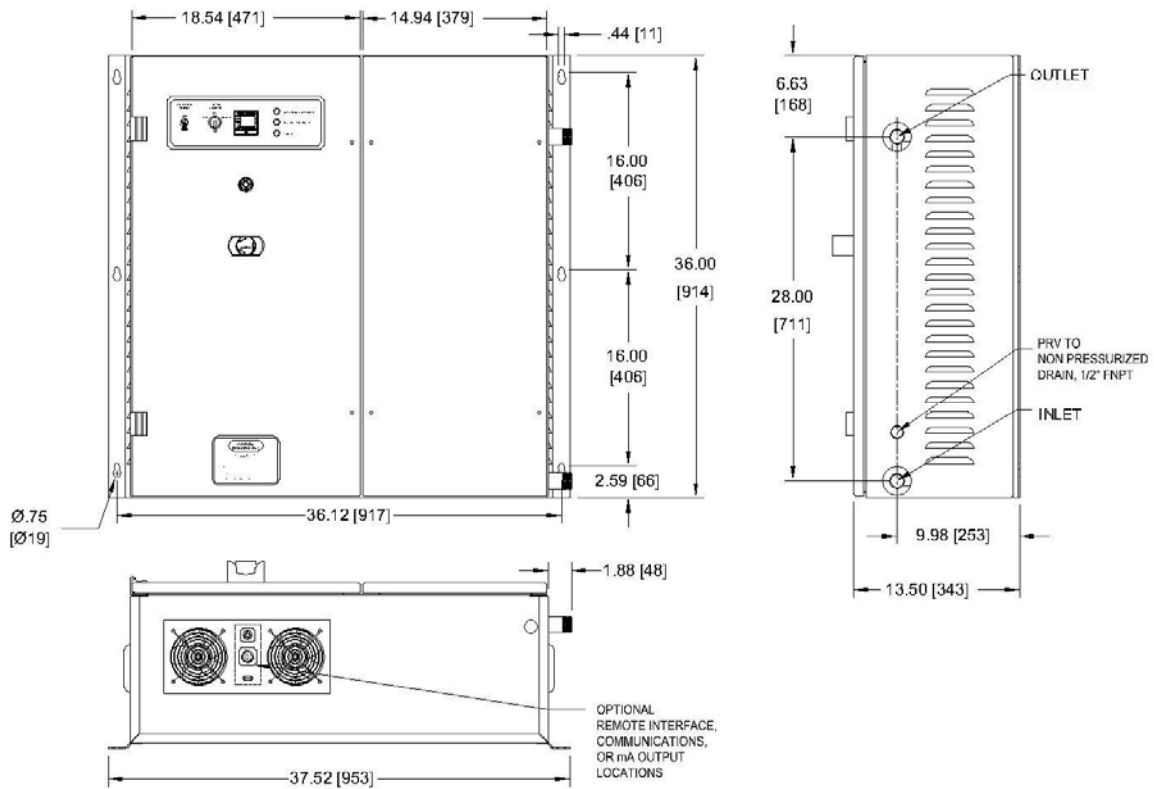

Figure 2: Dimensional Drawing, 72kW Unit

SYSTEM SPECIFICATIONS (Continued):

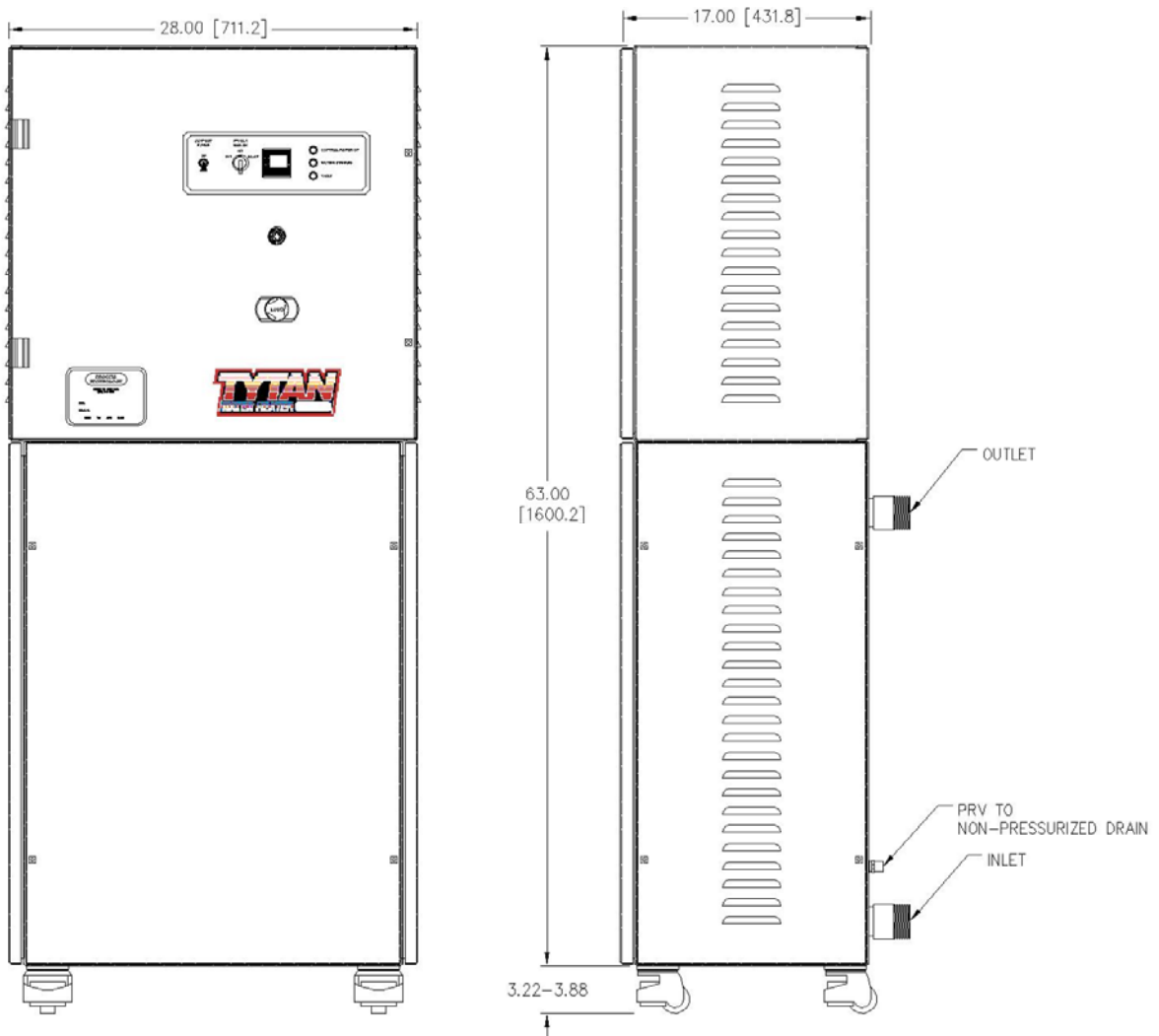

Figure 3: Dimensional Drawing, 96kW – 144kW Units

MODEL NUMBER:

Process Technology model numbers are designed to offer some description of the heater construction, including features and options. The model number can be found on the model/serial number label located on the front of the unit, near the bottom (see figures 1-3).

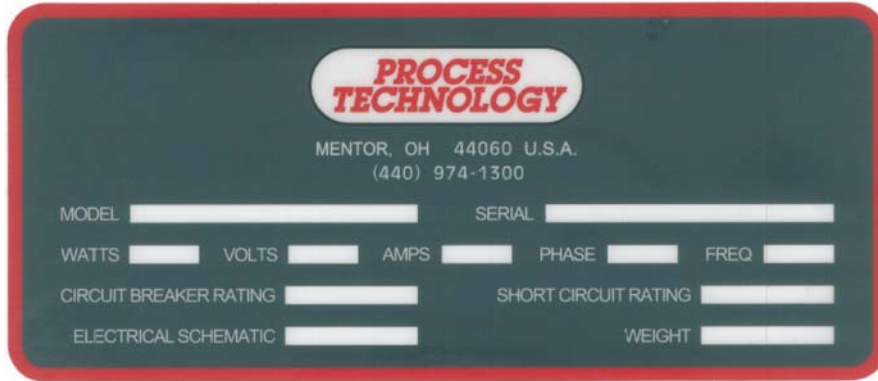

Figure 4: Model/Serial Number Label

Model Number (Continued):

Model Number Explanation:

Provided below is an example of a typical model number along with an explanation of each part. This key will help you understand your model number.

Model number example:

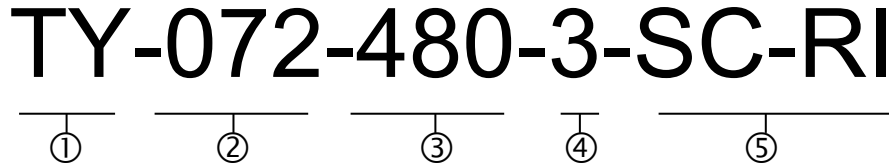

- ① **Heater Series.** The beginning of each model number will designate the product line. In this case, the TYTAN inline titanium water heater.
- ② **Heater Wattage.** The numerical portion of the model number will always begin with the wattage of your heater. The table provided below identifies the standard available wattage ratings and the number of heater columns needed to provide that amount of Wattage.

HEATER MODEL NUMBER	HEATER WATTAGE (W)	NUMBER OF HEATER COLUMNS	WATTAGE PER HEATING COLUMN (W)	HEATER MODEL NUMBER	HEATER WATTAGE (W)	NUMBER OF HEATER COLUMNS	WATTAGE PER HEATING COLUMN (W)
009	9,000	1	9,000	048	48,000	2	24,000
012	12,000	1	12,000	072	72,000	3	24,000
018	18,000	1	18,000	096	96,000	4	24,000
024	24,000	1	24,000	120	120,000	5	24,000
036	36,000	2	18,000	144	144,000	6	24,000

Table 4: Wattage and Column Table

Model Number (Continued):

TY-072-480-3-SC-RI

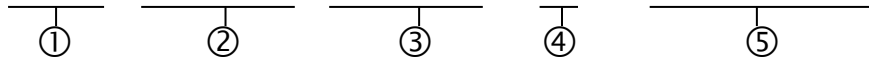

- ③ **Heater Voltage.** The first character following the heater Wattage will describe the rated Voltage of the heater.
- ④ **Heater Phase.** This character will specify if this unit is designed for single phase (-1) or three phase (-3) power.
- ⑤ **Options.** The remaining characters will specify any options included in this system. Many of these options can be combined on a single Tytan water heater. Only a few options are mutually exclusive.

Model Number	Option
-SC	Built to SEMI S3 standards, CE compliant version. Includes circuit breaker.
-PLC	PLC temperature controller, in place of the standard PID controller
-RI	Remote interface. This will allow the user to start, stop, reset the unit and monitor the safety circuit remotely.
-RC1	RS485 communications interface with the Omron PID temperature controller
-RC2	RS232 communications interface with the Omron PID temperature controller (requires non-standard controller)
-RC3	4-20mA process input (requires non-standard controller)
-MA	4-20mA process output (requires non-standard controller)
-S	316 Stainless steel wetted surfaces.
-SP	316 Stainless steel passivated wetted surfaces.
-SB	Seismic Brackets included.
-##	Special construction design, consult factory for details

Table 5: TYTAN Options

FACILITY REQUIREMENTS:

Before installing the TYTAN inline water heater confirm the facility requirements listed below.

Space Requirements:

The TYTAN inline water heater is constructed in a wall-mounted or freestanding enclosure. The dimensions of this enclosure are based upon the wattage of the unit. This enclosure includes the common framework for the heating column(s) as well as the electrical components.

The enclosure requires adequate ventilation. Locate equipment so that ventilation provisions on the bottom and sides of the enclosure are not obstructed. The ventilation fan exhausts air through these openings which prevents overheating of the interior. Be sure to provide adequate clearance for normal operation and maintenance of this heater.

The standard dimensions of the various models are shown in Table 3 (see appendix for custom made units). Allow additional space on all sides of the unit for the control ventilation and service access. (all dimensions are in inches).

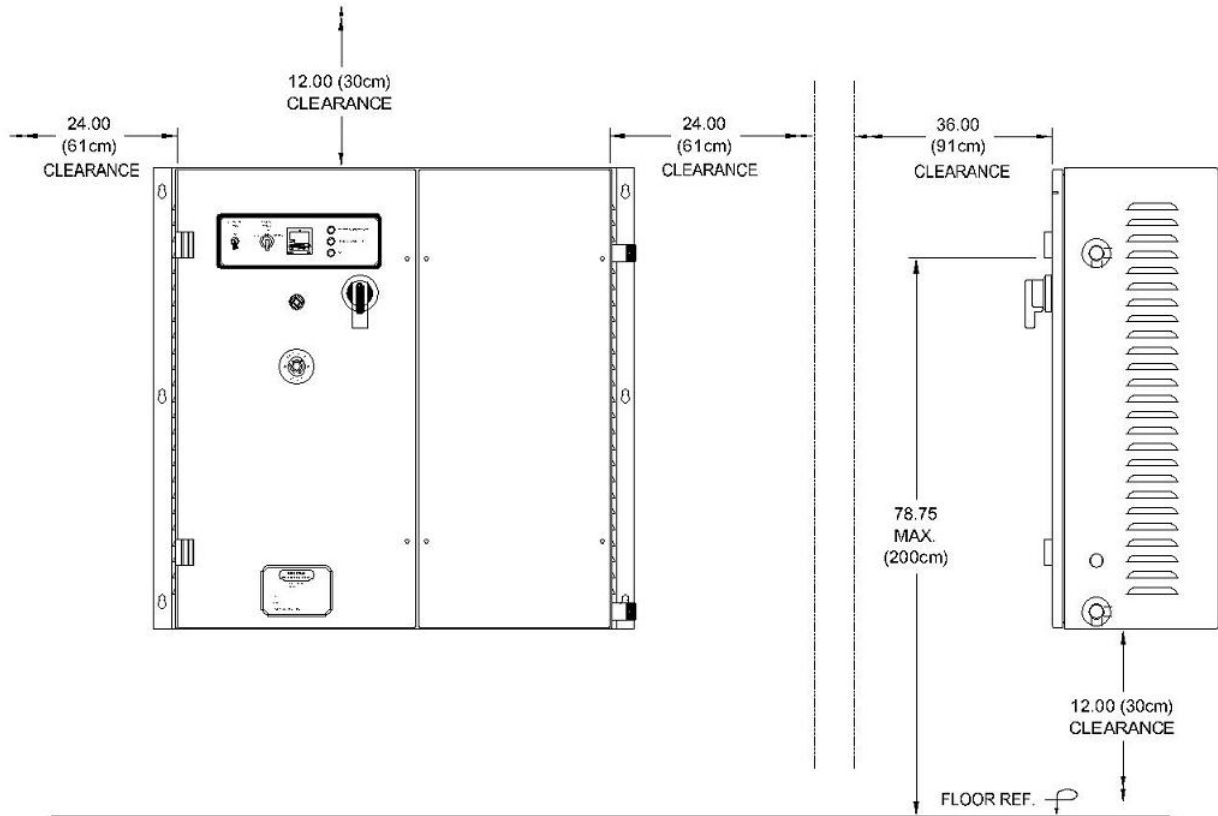

Figure 5: Clearance Dimensions for Wall-Mounted Units (72kW Model Shown)



Facility Requirements (continued):

Water Plumbing Requirements:

The customer supplied inlet and outlet plumbing must be rated to withstand temperatures up to 275°F (135°C) at pressures up to 100 psi (6.9 Bar).

The wall-mounted TYTAN units are supplied standard with 1-inch MNPT threaded pipe connections for the plumbing inlet and outlet. These connections extend from the right side of the unit, with the inlet near the bottom and the outlet near the top (see figures 1-2). There is also a ½-inch FNPT threaded pipe connection for the PRV valve on the right side of the enclosure which must be plumbed to a non-pressurized drain. Special plumbing connections are available as an option. Refer to your specific unit for any special connections.

The free-standing TYTAN units are supplied standard with 2-inch MNPT threaded pipe connections for the plumbing inlet and outlet. These connections extend from the back of the unit, with the inlet near the bottom and the outlet near the top (see figure 3). There is also a ½-inch FNPT threaded pipe connection for the PRV valve on the back of the enclosure, which must be plumbed to a non-pressurized drain. Special plumbing connections are available as an option. Refer to your specific unit for any special connections.

 ATTENTION	 CAUTION
N'inversez pas les raccords de tuyauterie de cet appareil. L'inversion de l'orientation correcte de la tuyauterie menera à des températures hautes et la panne du thermoplongeur.	Do not reverse the plumbing connections of this unit. Failure to observe the correct plumbing orientation will result in high-temperature conditions and heater failure.

Electrical Requirements:

NOTE: Ensure electrical power fusing and disconnects meet local jurisdictional requirements. Fuse ratings noted in this document are for reference only. Ensure external electrical components comply with local requirements before operating this unit.

Reference the model/ serial number label to identify the electrical power requirements of this unit (see figure 4). Verify that the incoming electrical service is rated and fused for the required amperage draw.



 ATTENTION	 CAUTION
Ne dépassez pas la tension indiquée. L'endommagement irrémédiable pourrait résulter à la colonne de chauffage ou aux circuits du contrôle.	Do not exceed the rated voltage. Irreparable damage to the heating column or control circuitry may result.

INSTALLATION:

NOTE: The mounting and installation of this unit should only be performed by qualified personnel.

Inspection and Uncrating:

The wall-mounted TYTAN units are shipped in a horizontal position. The free-standing TYTAN units are shipped in a vertical position.

 ATTENTION	 CAUTION
À cause du poids de l'appareil, NE BOUGEZ NI SOULEVEZ PAS l'appareil sans l'équipement approprié.	Due to the weight of the unit, DO NOT ATTEMPT to move or lift the unit without the appropriate material handling equipment.

- 1) Inspect the shipping crate for evidence of damage. If any damage is detected, contact the carrier immediately.
- 2) Inspect the shock sensors located on the outside of the crate. The shock sensors will indicate if the unit experienced rough handling. If the sensors indicate that the unit has experienced rough handling, contact the carrier immediately. If the shock sensor on the outside of the crate is missing, there is also a shock sensor located on the inside of the crate.



Figure 6: Shockwatch Sensor



Uncrating the wall-mounted units:

- 3) Remove the top of the crate.
- 4) Remove any protective packaging material and any other materials that may have been packed in the crate with the enclosure.
- 5) Remove any braces used to hold the unit in place during shipping.
- 6) Using a hoist or other suitable lifting device, lift the unit from the mounting holes on the side flanges and remove from the crate. Do NOT lift the unit by holding the plumbing connections or (if present) the disconnect handle.

INSTALLATION (Continued):

Uncrating the free-standing units:

- 3) Remove the front of the crate.
- 4) Remove any protective packaging material and any other materials that may have been packed in the crate with the enclosure.
- 5) Remove any braces used to hold the unit in place during shipping.
- 6) Using a hoist or other suitable lifting device, lift the unit from underneath and remove from the crate. Do NOT lift the unit by holding the plumbing connections or (if present) the disconnect handle.

 ATTENTION	 CAUTION
Ne basculez pas l'appareil plus de 10° de la verticale. Des blessures dangereuses ou l'endommagement de l'appareil pourraient résulter.	Do not tip the unit beyond 10° from vertical. Serious personal injury or equipment damage may result.

INSTALLATION (Continued):

Positioning and Mounting:



Wall-mounted units:

The wall-mounted TYTAN units must be anchored to a support structure that can support at least 275-pounds (125 kg). We recommend that the mounting bolts are no smaller than a 3/8-16 thread.



We recommend that the unit is mounted such that the temperature controller is no more than 78-inches (2 meters) above the floor level (see figure 5).

Free-standing units:

Move the unit into position by lifting the unit from underneath using a fork truck or other suitable handling equipment. Position the equipment to avoid damaging the cooling fans located on the bottom of the unit.

 ATTENTION	 CAUTION
<p>Les roulettes ne doivent pas être utilisées pour déplacer l'appareil de longues distances ni sur les surfaces irrégulières. Elles sont prévues de faciliter la position de l'appareil dans sa place d'opération. Déplacez l'appareil lentement car il n'y a pas de manière de ralentir ni d'arrêter l'appareil. Assurez qu'il y a du personnel suffisant pour déplacer l'appareil sans risque. Ne pas suivre ces instructions peut mener à des blessures graves et/ou l'endommagement de l'appareil.</p>	<p>The castors should not be used to move the unit over long distances or on uneven surfaces. They are intended to facilitate small adjustments to the position of the unit at its place of operation. Move the unit slowly, as there is no means of slowing or stopping the unit. Ensure that there are sufficient personnel to move the unit safely. Failure to follow these instructions can result in serious personal injury and/or damage to the unit.</p>

Place the unit on a hard, level surface. Ensure the unit is secured so as not to roll as the castors are unlocked. Once the unit is in position, lock the four castors.

 ATTENTION	 CAUTION
<p>Assurez que l'appareil est sur une surface plane et qu'il y a du personnel suffisant à tenir l'appareil en place. Pendant que les pieds d'aplanissement sont rétractés et l'appareil reste sur les roulettes, un mouvement inattendu peut résulter. Ne pas fixer correctement l'appareil peut mener à des blessures graves et/ou l'endommagement de l'appareil.</p>	<p>Ensure the unit is on a smooth, level surface and there are sufficient personnel to hold the unit in place. As the leveling feet are retracted and the unit rests on the castors unexpected movement may result. Failure to properly secure the unit may result in serious personal injury and/or damage to equipment.</p>

INSTALLATION (Continued):

Positioning and Mounting (Continued):

-SB option, seismic brackets included (free-standing units only):

If the heater installation requires that seismic brackets be used, the “SB” option will need to be provided. The top-half of these brackets will be installed on the cabinet at the factory.

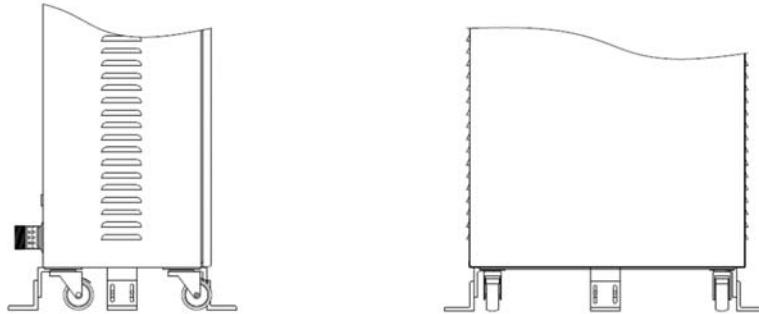
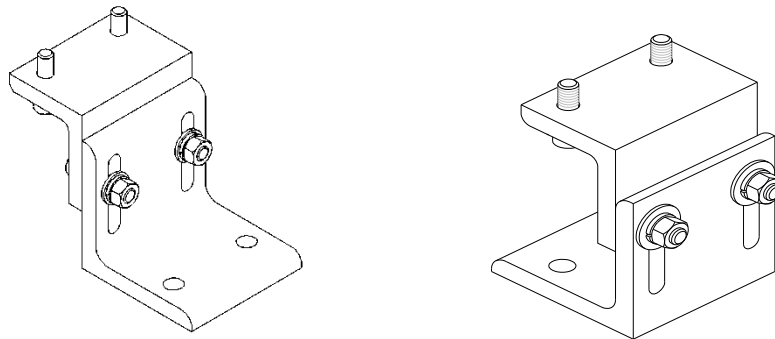

Figure 7: Seismic Brackets Installed (facing outward orientation)

For shipping purposes only, the bottom-half of the seismic bracket will be attached to the top-half, but upside down. For installation, remove and secure the bottom -half to the floor and to the top-half as shown in Figures 7 and 8.



Bottom facing outward



Bottom facing inward

Figure 8: Seismic Bracket Assembled, two possible orientations

INSTALLATION (Continued):



Plumbing:

The plumbing installation of this unit should only be performed by qualified technicians.

 ATTENTION	 CAUTION
Vérifier que l'eau est coupée et que les dispositifs de déconsignation sont correctement installés.	Verify that the water supply is shut off, and any necessary lockout/tagout devices are properly installed.

The customer supplied inlet and outlet plumbing must be rated for temperatures up to 275°F (135°C) at pressures up to 100 psi (6.9 Bar).

On all TYTAN units, the lower plumbing connection will always be the inlet, and the upper plumbing connections will always be the outlet. The inlet plumbing to the unit must include the means to drain the unit, which may be necessary in the case of replacing the heating column or other parts.

 ATTENTION	 CAUTION
N'inversez pas les raccords de tuyauterie de cet appareil. L'inversion de l'orientation correcte de la tuyauterie menera à des températures hautes et la panne du thermoplongeur.	Do not reverse the plumbing connections of this unit. Failure to observe the correct plumbing orientation will result in high-temperature conditions and heater failure.

INSTALLATION (Continued):

Plumbing (Continued):

When tightening all connections on this unit, be sure to support the TYTAN heater connection to prevent excessive torque or strain from damaging the internal plumbing of the unit.

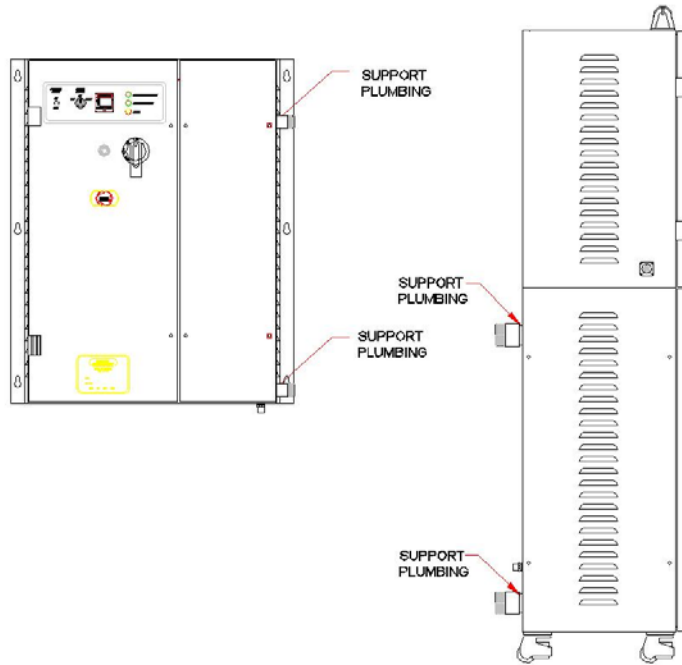



Figure 9: Tytan Heater Connection Support

 ATTENTION	 CAUTION
Ne pas soutenir correctement les raccords de tuyauterie du TYTAN pendant la serrure menera à l'endommagement de l'appareil et les fuites d'eau internes. Tel endommagement n'est pas couvert par la garantie de l'appareil.	Failure to properly support the TYTAN plumbing connections during tightening will result in equipment damage and internal water leaks. Such damage is not covered under the product warranty.

Inlet/Outlet Plumbing Connections:

- 1) Remove the protective plastic caps from inlet and outlet plumbing.
- 2) Test fit the piping to insure proper length.
- 3) Support the TYTAN pipe fittings to avoid any damage during tightening.
- 4) Tighten the connections as required. Take care not to over-tighten.
- 5) Establish water flow through the unit. Inspect the plumbing for leaks.

INSTALLATION (Continued):



Plumbing (Continued):

PRV Plumbing Connection:

- 1) Test fit the drain pipe to insure proper length. The PRV must be connected to a non-pressurized drain.
- 2) Support the TYTAN PRV fitting to avoid any damage during tightening.
- 3) Tighten the connection as required. Take care not to over-tighten.

Wiring:

The wiring of this unit should only be performed by qualified technicians.

 ATTENTION	 CAUTION
<p>Vérifiez que l'alimentation électrique est coupée, et tous les périphériques de verrouillage / débranchement nécessaires sont correctement installés.</p>	<p>Verify that the electrical power supply is shut off, and any necessary lockout/tagout devices are properly installed.</p>

Power Connections:

TYTAN units are designed to operate on 4 wire electrical power supplies (3 power wires, 1 ground wire). All electrical connections should conform to local electrical codes and/or NFPA 70/79.

There is no pilot hole for incoming power supply conduit. This hole will have to be cut in the top of the enclosure during installation.

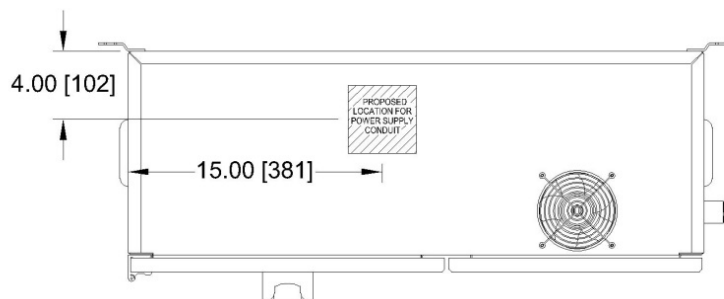



Figure 10: Recommended location for power supply conduit (72kW unit shown)

- 1) Check the model/serial number on the front of the unit for power requirements.

 ATTENTION	 CAUTION
<p>Ne pas dépasser la tension nominale. Des dommages irréparables à la colonne de chauffage ou circuits de commande peut entraîner.</p>	<p>Do not exceed the rated voltage. Irreparable damage to the heating column or control circuitry may result.</p>

INSTALLATION (Continued):

Wiring:

- 2) Remove front cover of the control side of the cabinet by loosening the cover mounting screws.
- 3) Cut a hole in the top of the enclosure for the incoming power supply to allow for the power supply to enter the top of the enclosure.
- 4) Fuse the incoming line for the rated amperage using an approved electrical disconnect box.
- 5) Connect the leads from the incoming power line to the appropriate terminals (reference the Electrical Schematic) making sure not to disturb existing wiring. Use care that no loose strands of wire are exposed out of the terminal connection. Torque all wires to the specified ratings located on the wiring diagrams and component labels.

<u>TORQUE SPECIFICATIONS</u>	
CIRCUIT BREAKER	
DISTRIBUTION BLOCK	
PRIMARY:	
SECONDARY:	
SECONDARY:	
POWER FUSES	
SAFETY CONTACTOR	
SOLID STATE RELAYS	
INPUT :	
OUTPUT :	

Figure 11: Torque Specifications Label

- 6) Grounding is done internally from the Incoming Power Strip.

INSTALLATION (Continued):

Wiring:

RC1 (RS232), RC2 (RS485) Options: Serial Communication Interface:

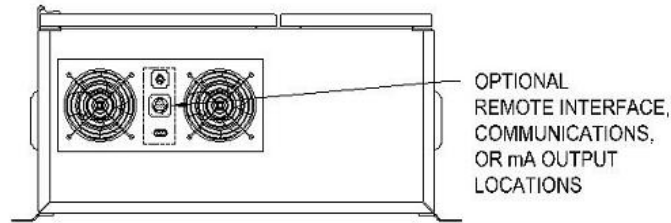

Figure 12: Location of optional interface connections

In units supplied with the RC1 (RS485) or RC2 (RS232) options, the Omron E5CN-H temperature controller is equipped with RS-232 / RS-485 Serial Communication capability for use with a customer-supplied host computer. If this option is used, all temperature and related parameters can be monitored or altered from the host computer. On these units, the communications wiring is made through a DB-9 receptacle located on the side or bottom of the cabinet. An independent serial cable should be installed between the host computer and the DB-9 receptacle (not included with unit).

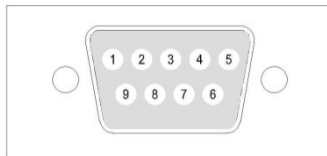

Figure 13: DB9 connector, for optional -RC# remote communications

RC1 (RS485) Communications pin assignment:

Pin Number	Signal
2	Positive (+)
3	Negative (-)
1, 4, 5, 6, 7, 8, 9	Not used

RC2 (RS232) Communications pin assignment:

Pin Number	Signal
2	Send
3	Receive
5	Signal Ground
1, 4, 6, 7, 8, 9	Not used

INSTALLATION (Continued):

Wiring:

RC3 (4-20 mA) Option: Process Remote Set Point:

Units provided with the RC3 option will include a 4-pin connector plug, for wiring of the 4-20 mA process remote set point. This will allow the user to change the process set point of the Tytan heater from a remote device. This signal is an input only. Note: When the –RC3 and –RI options are purchased together, these four pins will be incorporated into the 16 pin connector pictured below in figure 13.

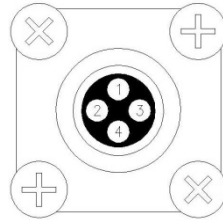

Figure 14: 4-pin connector plug, for –MA and –RC3 options

Pin Number	Signal
1	Positive (+)
2	Negative (-)
3, 4	Remote Set Point Enable

MA (4-20 mA) Option: Process Output:

Units provided with the MA option will include a 4-pin connector plug, for wiring of the 4-20 mA process output. This process output will allow the user to record the outlet temperature of the Tytan heater from a remote device. This signal is an output only. This option uses the same 4 pin adapter as the –RC3 option pictured in figure 12. Note: When the –MA and –RI options are purchased together, these four pins will be incorporated into the 16 pin connector pictured below in figure 15.

MA option process output pin assignment:

Pin Number	Signal
1	Positive (+)
2	Negative (-)
3, 4	Not used

INSTALLATION (Continued):

Wiring:

RC3 (4-20 mA input) plus MA (4-20mA output) Options: Process Remote Set Point:

Units provided with the RC3 and MA options will include a 16-pin connector plug. The RC3 option will allow the user to change the process set point of the Tytan heater from a remote device. This signal is an input only.

The MA option will allow the user to record the outlet temperature of the Tytan heater from a remote device. This signal is an output only.

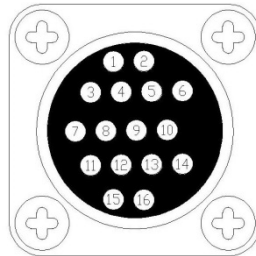

Figure 15: 16-pin connector plug, for optional RC3-MA and -RI remote interface

RI Option: Remote Interface:

Units provided with the RI option will include a 16-pin connector plug which will allow remote operation of the Tytan inline water heater. The remote interface will allow remote operation of heater start/stop, remote EMO trip and remote monitoring of heater enabled and the status of the alarm system. Some of the remote interface inputs have been jumped at the factory, to allow for heater operation with the remote interface cable disconnected. These jumpers are located in the electrical side of the heater cabinet, and are marked by a red tag. If the customer wants to use the remote interface, these red tag jumpers must be removed.

If the unit was provided with a custom remote interface (**-RI#** at the end of the model number), then refer to the electrical prints (provided with the unit) for your specific signals and pin-out assignments.

INSTALLATION (Continued):

Wiring:

RI option process output pin assignment:

Pin Number	Signal	Signal type	Description
1, 2	EMO	Input, Dry contacts	The customer supplied remote controller can trip an EMO condition on the unit by opening contacts across these two pins. This is one of the signals that has been bypassed at the factory. In order to use this remote EMO feature, the red tag jumper must be removed. The EMO condition must be reset at the unit.
3, 4	Start/Stop	Input, Dry contacts	The customer supplied remote controller can start heater operation by closing the contacts across these pins, when the controller is in REMOTE mode only. This is one of the signals that has been bypassed at the factory. In order to use this remote Start/Stop feature, the red tag jumper must be removed. Open contacts will stop heater operation.
7, 8	Process Output	4-20mA (pin 7+, pin 8-)	This output will provide a scaled 4-20mA signal proportional to the outlet process temperature of the Tytan heater. Requires –MA option.
9, 10	System Fault	Output, Dry Contacts	This output will apply open contacts across these pins when any alarm condition has been tripped. Once the alarm condition has been corrected, the unit will require a manual reset at the unit. The unit cannot be reset remotely. Closed contacts indicate all of the safety devices are in normal operating mode.
11, 12	Heater Enabled	Output, Dry contacts	This output will apply closed contacts across these pins when power is applied to the unit, there is not EMO condition and the heater selector switch is set to ON. Open contacts indicate the EMO has been tripped or the unit has been stopped or shut down.
13, 14	Remote Set Point	Input, 4-20 mA (pin 13-, pin 14+)	This input signal will override the SP0 set point on the controller when there is continuity between input pins 15 and 16. Requires –RC3 option.
15, 16	Remote Set Point Enable	Input, Dry Contacts	When the contacts are open, the controller will use the local SP0 setting for operation. When these contacts are closed, the controller will use the input signal from pins 13-14 for the set point.

OPERATIONS:

Control Panel:

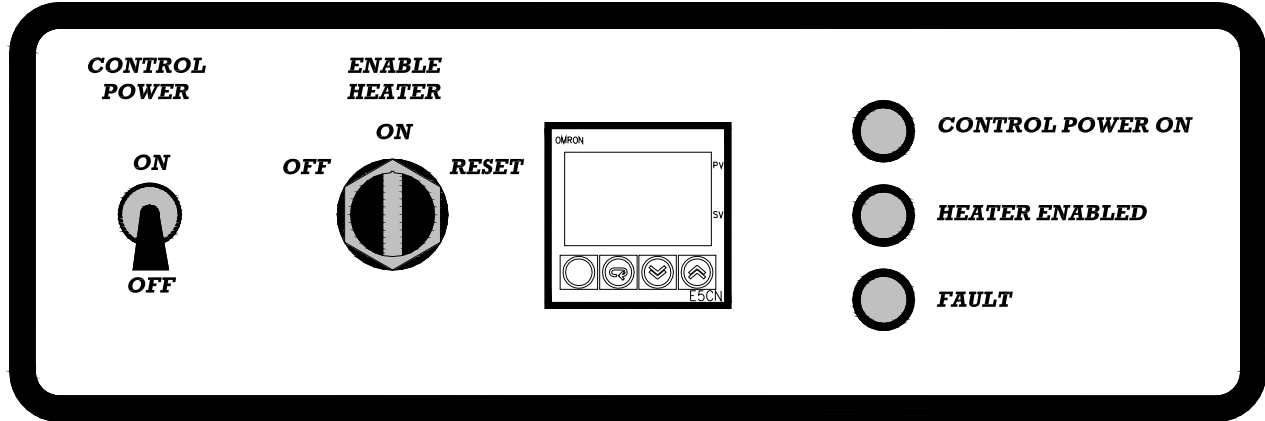



Figure 16: Temperature Controller and Control Panel.

The TYTAN Heating System incorporates a self-tuning, PID microprocessor based, digital temperature controller with a set high temperature alarm. The PID feature enhances the controller's ability to reach and maintain a constant process temperature. The self-tuning feature enables the controller to measure the process characteristics and indicate desired values, which can be displayed on LED displays.

The following sections provide a description and instructions for the available temperature controllers. For a complete user guide, visit the Omron website at www.omron.com.

1. Omron's E5CC and E5CN (older version) controllers are used on standard Tytan heaters and heaters with the RC1, RC3 or MA options.
2. Omron's E5EC and E5EN-H (older version) controllers are used on Tytan heaters with the RC3-MA option.
3. Omron's E5CN-H controller is used on Tytan heaters with the RC2 option.

 ATTENTION	 CAUTION
Ce programme de régulateurs de température différente , et ont légèrement différents paramètres de contrôle . Assurez-vous de consulter la section correcte du contrôleur de température lors de la programmation de votre appareil. Dommages contrôleur peut entraîner.	These temperature controllers program differently, and have slightly different control settings. Be sure to refer to the correct temperature controller section when programming your unit. Controller damage may result.

OPERATIONS (Continued):

Display Symbols (Common):

The following tables show the correspondence between symbols shown on the No.1 and No.2 displays and alphabetic characters.





A	b	C	d	E	F	G	H	I	J	K	L	M
A	B	C	D	E	F	G	H	I	J	K	L	M

N	o	P	Q	R	S	T	U	V	W	X	Y	Z
N	O	P	Q	R	S	T	U	V	W	X	Y	Z

Figure 17: Omron Temperature Controller Display Symbols

Using the keys (Common):

This section describes the basic functions of the front panel keys.

-  **Level Key:** Press this key to move between setting levels. The setting level is selected in the following order: operation level: adjustment level, initial setting level, communications setting level.
-  **Mode Key:** Press this key to change parameters within a setting level. The parameters can be reversed by holding down the key (moving one per second in reverse order).
-  **Up Key:** Each press of this key increments the value displayed on the No. 2 display or advances the setting. Holding the key down speeds up the incrementation.
-  **Down Key:** Each press of this key decrements values displayed on the No. 2 display or reverses the setting. Holding the key down speeds up the incrementation.

OPERATIONS (Continued):

Temperature Controller (E5CC / E5CN):

The Omron E5CC and E5CN (older version) controllers are used on standard Tytan heaters and heaters with the RC1, RC3 or MA options.

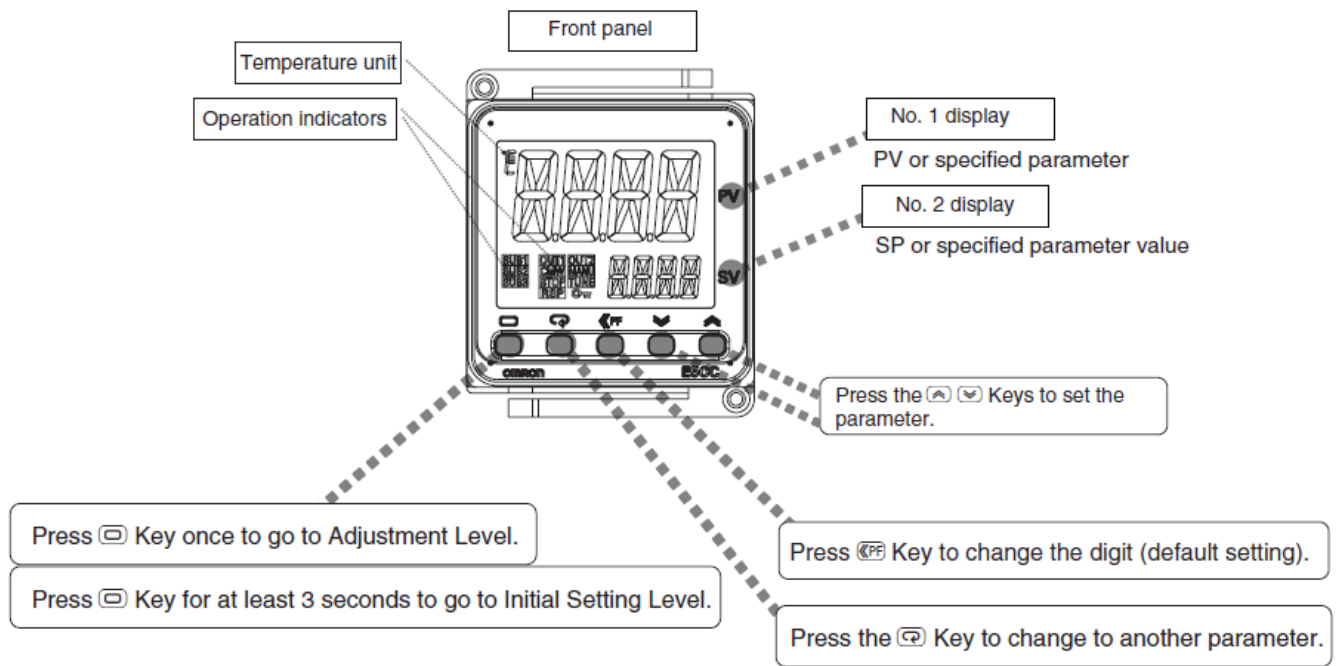

Figure 18: Omron E5CC Temperature Controller

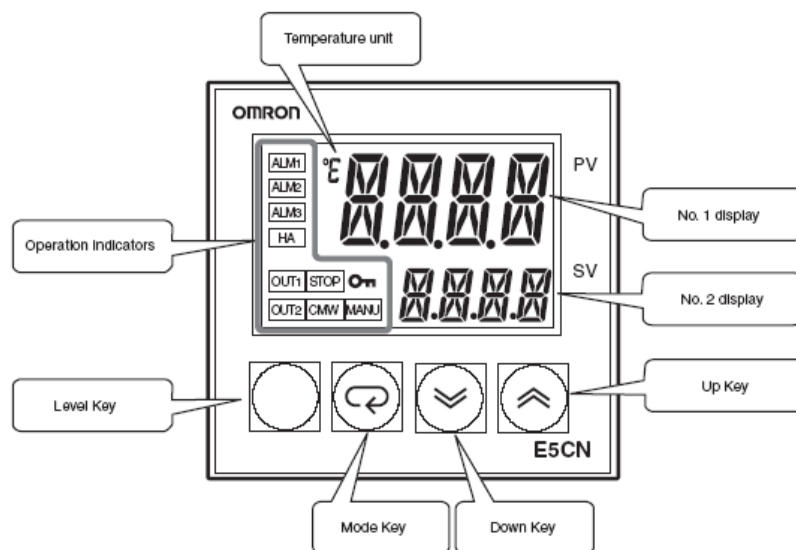

Figure 19: Omron E5CN Temperature Controllers

OPERATIONS (Continued):

Operation Indicators (E5CC / E5CN):

No. 1 display (PV): Shows the process value (outlet temperature), modes and parameter symbols.

No. 2 display (SV): Shows set points, parameter operation read value, or the variable input value.

SUB 1 / ALM1: Illuminates when the alarm 1 setting is ON (tripped) (120°C).

SUB 2 / ALM2: Illuminates when the alarm 2 setting is ON (tripped) (110°C).

SUB 3 / ALM3: Not used / available.

HA: Not used / available (E5CN only).

OUT1: Illuminates when the control output 1 is ON.

OUT2: Illuminates when control output 2 is ON (Not used).

STOP: Illuminates when the control operation has stopped.

CMW: Illuminates when communications wiring is enabled.

On : Illuminates when setting change protection is ON.

MANU: Not used / available.

TUNE: Illuminates during PID autotuning (E5CC only)

RSP: Illuminates during remote setpoint mode (E5CC only)

Selecting Menu Levels (E5CC / E5CN):

The following section describes how to access the various menu levels in the Omron controller.

Operations Level: Press the **mode** key.

Adjustment Level: Press and hold the **level** key for at least 1 second.

Initial Setting Level: Press and hold the **level** key for at least 3 seconds.

Protect Level: Press and hold the **level** key and the **mode** key simultaneously for at least 3 seconds.

OPERATIONS (Continued):

Mode Parameter Settings (E5CC / E5CN):

The Omron E5CC / E5CN temperature controller has been programmed prior to shipment, so no additional programming is normally necessary. The table below shows the various controller settings for this unit when properly configured to operate the TYTAN inline heater. Some internal menus have been factory programmed and subsequently locked. Those menus are not listed.

Level	Parameter	Description	Setting
Operations Level	R-S	Run – Stop selection	RUN
	AL-1	Alarm value 1	120°C
	AL-2	Alarm value 2	110°C
Adjustment Level	LAdJ	Adjustment level	
	At	Autotune execute	OFF
	INS	Temperature input shift	0.0*
	P	Proportion band	80**
	I	Integral time	233**
	D	Derived time	40**
	SPRt	SP ramp set value	OFF
	OL-H	MV upper limit	100.0
	OL-L	MV lower limit	0.0

* Value may differ per calibration requirements

** The P, I and D values may change following the execution of Auto-tune.

Table 6: Omron E5CC / E5CN Parameters

Changing Primary Set Point (E5CC / E5CN):

1. The process Set Point can be changed in the normal display mode.
2. Press the up and down arrow keys to select the desired setting.



After changing the process set point on the Omron controller, you must manually adjust the SP2 setting on the Future Design *over-temperature control*. See OPERATIONS Over-Temperature Controller FDC-L91 section.

OPERATIONS (Continued):

High Alarm (E5CC / E5CN):

The Omron E5CC / E5CN temperature controller incorporates an independent high-temperature alarm. Alarm 1 (AL-1) prevents heater operation above a preset maximum temperature that may harm the process and potentially the tank material. If the process temperature exceeds the preset high alarm value, the heater will be disengaged and the audibly alarm will sound. The temperature controller will activate once the process temperature exceeds the set point by the preset value. The factory setting of this alarm temperature is 248°F (120°C).

The high alarm value can be adjusted to a lower setting through the operations level.

1. Press the mode key  to enter the operations level.
2. Press the mode key  to index through the operations level to the AL-1 setting.
3. Press the up or down key to adjust AL-1 to the desired setting.
4. Press the mode key  to index through the operations level to the AL-2 setting.
5. The AL-2 setting is normally set at 10°C below AL-1. Press the up and down keys to adjust AL-2 to the desired setting.
6. Press and hold the level key for a minimum of three seconds to return to the normal display.

PID Tuning (E5CC / E5CN):

The Omron E5CC / E5CN temperature controller incorporates the capability of automatically tuning the PID parameters (Auto-Tuning) to fit the characteristics of the process. The optimum PID parameters are automatically set by forcibly changing the Manipulated Variable (MV) to calculate the characteristics (limit cycle method) of the control target. When the auto tuning is complete, the appropriate PID tuning parameters will be automatically installed into the non-volatile memory of the temperature controller.

1. Turn on water supply and set the desired water flow.
2. Set the Process Temperature Set point to the desired value (See **OPERATIONS; Changing Primary Set point**).
3. Press and hold the level key for a minimum of one second to enter the adjustment level.
4. Press the mode key to index through the adjustment level to get to the **At** setting.
5. Press the up or down arrow key to adjust the value to **At-2**.
6. Press and release the level key to return to the normal display. Verify the **TUNE** indicator is lit during autotuning (E5CC only) or that the display blinks (E5CN only).
7. Turn the ENABLE HEATER switch past the ON position to the RESET position, then release the switch, which will move to the ON position. If all criteria for the various safety devices have been met, the heater will begin to heat.
8. When the process is complete, the appropriate PID tuning parameters will be installed and retained in the non-volatile memory.

OPERATIONS (Continued):

Temperature Controller (E5EC / E5EN-H):

The Omron E5EC and E5EN-H (older version) controllers are used on Tytan heaters with the RC3-MA option.

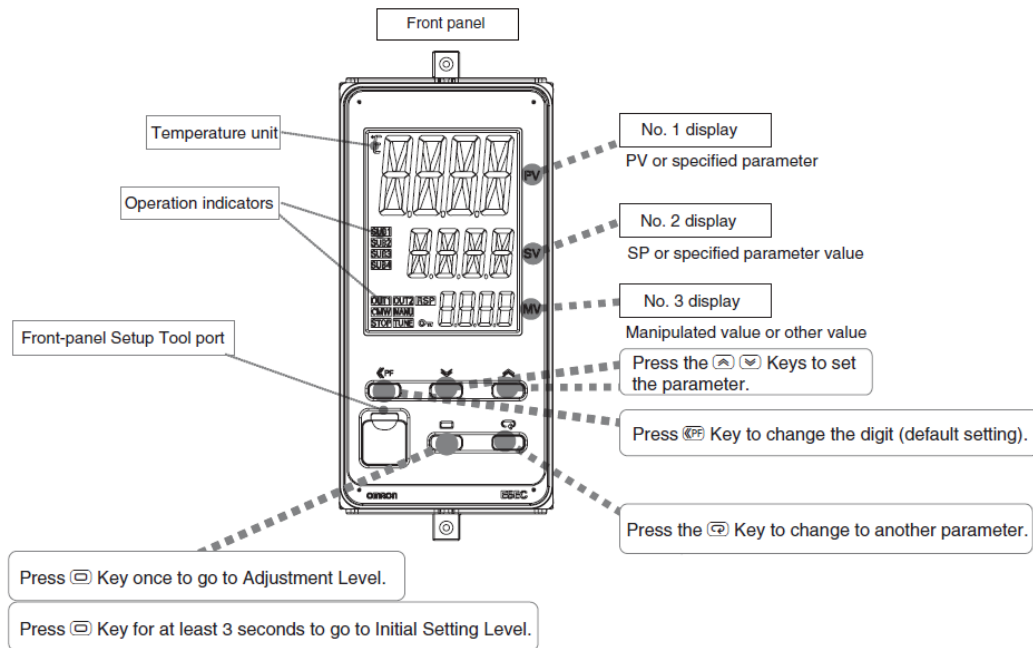

Figure 20: Omron E5EC Temperature Controller

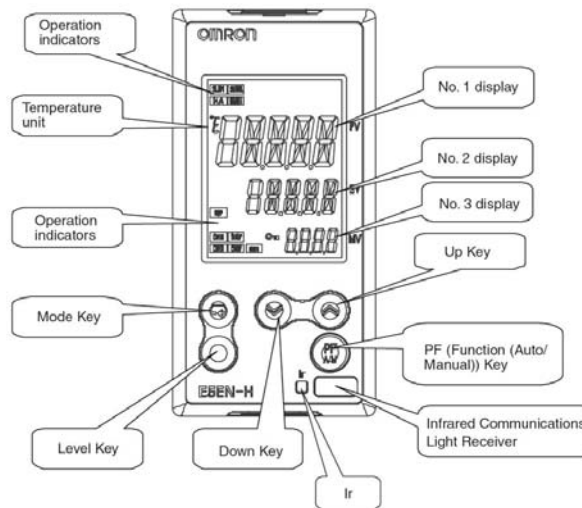

Figure 21: Omron E5EN-H Temperature Controller

OPERATIONS (Continued):

Operation Indicators (E5EC / E5EN-H):

- No. 1 display (PV):** Shows the process value (outlet temperature), modes and parameter symbols.
- No. 2 display (SV):** Shows set points, parameter operation read value, or the variable input value.
- No. 3 display (MV):** Not used.
- SUB1:** Illuminates when the alarm 1 setting is ON (tripped) (120°C).
- SUB2:** Illuminates when the alarm 2 setting is ON (tripped) (110°C).
- SUB3:** Not used / available.
- SUB4:** Not used / available (E5EC only).
- HA:** Not used / available (E5EN-H only).
- OUT1:** Illuminates when the control output 1 is ON.
- OUT2:** Illuminates when control output 2 is ON (Not used).
- STOP:** Illuminates when the control operation has stopped.
- CMW:** Illuminates when communications wiring is enabled.
- On :** Illuminates when setting change protection is ON.
- MANU:** Illuminates when the controller is in Manual operation mode.
- TUNE:** Illuminates during PID autotuning (E5EC only)
- RSP:** Illuminates during remote setpoint mode (E5EC only)

Selecting Menu Levels (E5EC / E5EN-H):

The modes are selected by pressing the Level Key for one second or greater. The up and down arrow keys allow the movement between modes in the top display.

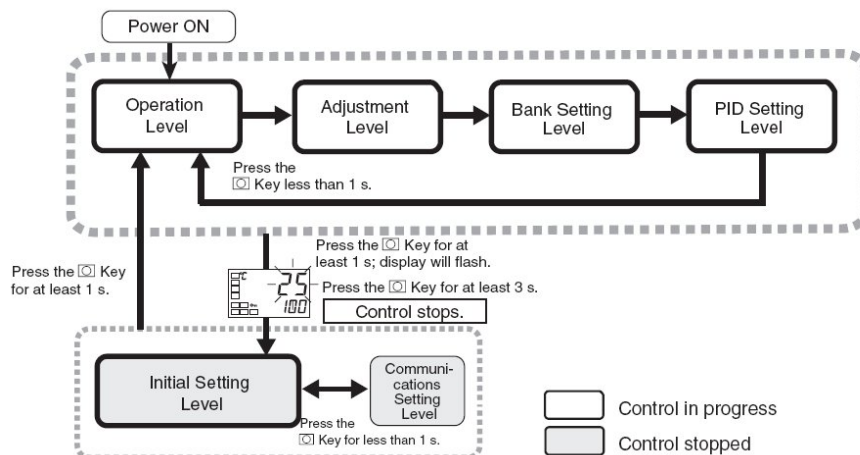

Figure 22: Omron E5EC / E5EN-H Menu Navigation

OPERATIONS (Continued):

Mode Parameter Settings (E5EC / E5EN-H):

The Omron E5EN-H temperature controller has been programmed prior to shipment, so no additional programming is normally necessary. The table below shows the various controller settings for this unit when properly configured to operate the TYTAN inline heater. Some internal menus have been factory programmed and subsequently locked. Those menus are not listed.

Level	Parameter	Description	Setting
Operations Level	bANK (E5EN-H only)	Bank number	0
	rSP	Remote set point monitor. This setting will not appear if unit is in remote mode.	Display Only
	SP-M	Set point ramp monitor	Display Only
	R-S	Run – Stop selection	RUN
	AL-1	Alarm value 1	120°C
	AL-2	Alarm value 2	110°C
Adjustment Level	LAdJ	Adjustment level	
	At	Autotune execute	OFF
	iRdA	Infrared communications use	OFF
	iNS	Temperature input shift	0.0*
	P	Proportion band	8**
	I	Integral time	233**
	D	Derived time	40**
	SPRt	SP ramp set value	OFF
	OL-H	MV upper limit	100.0
	OL-L	MV lower limit	0.0

* Value may differ per calibration requirements

** The P, I and D values may change following the execution of Auto-tune.

Table 7: Omron E5EC / E5EN-H Parameters

Changing Primary Set Point (E5EC / E5EN-H):

1. The process Set Point can be changed in the normal display mode.
2. Press the up and down arrow keys to select the desired setting.



After changing the process set point (SP-0) on the Omron controller, you must manually adjust the SP2 setting on the Future Design *over-temperature control*. See OPERATIONS Over-Temperature Controller FDC-L91 section.

OPERATIONS (Continued):

High Alarm (E5EC / E5EN-H):

The Omron E5EC / E5EN-H temperature controller incorporates an independent high-temperature alarm. Alarm 1 (AL-1) prevents heater operation above a preset maximum temperature that may harm the process and potentially the tank material. If the process temperature exceeds the preset high alarm value, the heater will be disengaged and the audibly alarm will sound. The temperature controller will activate once the process temperature exceeds the set point by the preset value. The factory setting of this alarm temperature is 248°F (120°C).

The high alarm value can be adjusted to a lower setting through the operations level.

1. Press the mode key  to enter the operations level.
2. Press the mode key  to index through the operations level to the AL-1 setting.
3. Press the up or down key to adjust AL-1 to the desired setting.
4. Press the mode key  to index through the operations level to the AL-2 setting.
5. The AL-2 setting is normally set at 10°C below AL-1. Press the up and down keys to adjust AL-2 to the desired setting.
6. Press and hold the level key for a minimum of three seconds to return to the normal display.

PID Tuning (E5EC / E5EN-H):

The Omron E5EC / E5EN-H temperature controller incorporates the capability of automatically tuning the PID parameters (Auto-Tuning) to fit the characteristics of the process. The optimum PID parameters are automatically set by forcibly changing the Manipulated Variable (MV) to calculate the characteristics (limit cycle method) of the control target. When the auto tuning is complete, the appropriate PID tuning parameters will be automatically installed into the non-volatile memory of the temperature controller.

1. Turn on water supply and set the desired water flow.
2. Set the Process Temperature Set point to the desired value (See **OPERATIONS; Changing Primary Set point**).
3. Press and hold the level key for a minimum of one second to enter the adjustment level.
4. Press the mode key to index through the adjustment level to get to the **At** setting.
5. Press the up or down arrow key to adjust the value to **At-2**.
6. Press and release the level key to return to the normal display. Verify the **TUNE** indicator is lit during autotuning (E5EC only) or that the display blinks (E5EN-H only).
7. Turn the ENABLE HEATER switch past the ON position to the RESET position, then release the switch, which will move to the ON position. If all criteria for the various safety devices have been met, the heater will begin to heat.
8. When the process is complete, the appropriate PID tuning parameters will be installed and retained in the non-volatile memory.

OPERATIONS (Continued):

Temperature Controller (E5CN-H):

The Omron E5CN-H temperature controller is used on Tytan heaters that utilize the RC2 options.

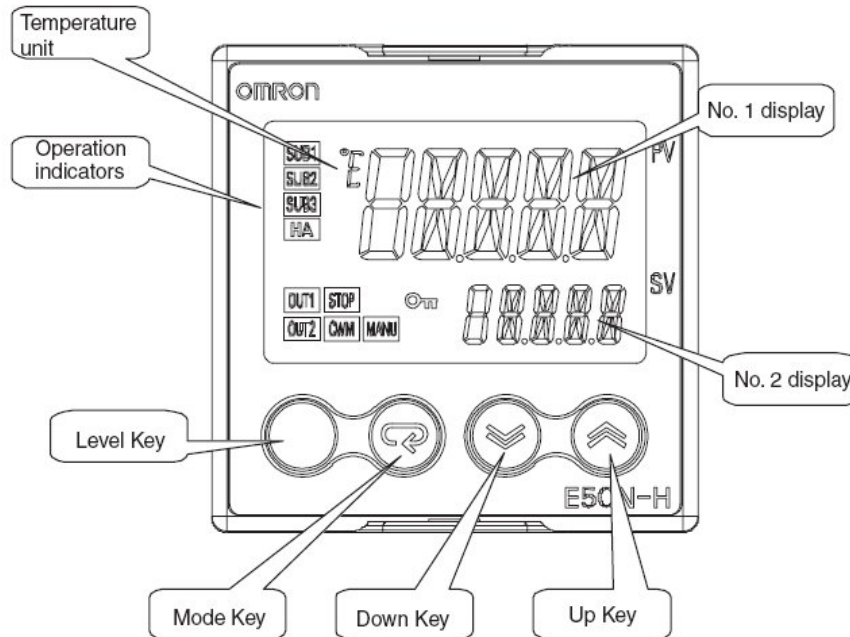

Figure 23: Omron E5CN-H Temperature Controller

Display Features (E5CN-H):

No. 1 display (PV): Shows the process value (outlet temperature), modes and parameter symbols.

No. 2 display (SV): Shows set points, parameter operation read value, or the variable input value.

Level key: Switches the controller between auto and manual operation.

Mode key: Press this key to change parameters within a setting level.

Up and Down arrow keys: Advances, increases or decreases the setting or values in the No. 2 display. Holding these keys down will speed up the rate of change.

OPERATIONS (Continued):

Operation Indicators (E5CN-H):

- SUB1:** Illuminates when the alarm 1 setting is ON (tripped) (120°C).
SUB2: Illuminates when the alarm 2 setting is ON (tripped) (110°C).
SUB3: Not used / available.
HA: Not used / available.
OUT1: Illuminates when the control output 1 is ON.
OUT2: Illuminates when control output 2 is ON (Not used).
STOP: Illuminates when the control operation has stopped.
CMW: Illuminates when communications wiring is enabled.
On : Illuminates when setting change protection is ON.
MANU: Illuminates when the controller is in Manual operation mode.

Selecting Menu Levels (E5CN-H):

The modes are selected by pressing the Level Key for one second or greater. The up and down arrow keys allow the movement between modes in the top display.

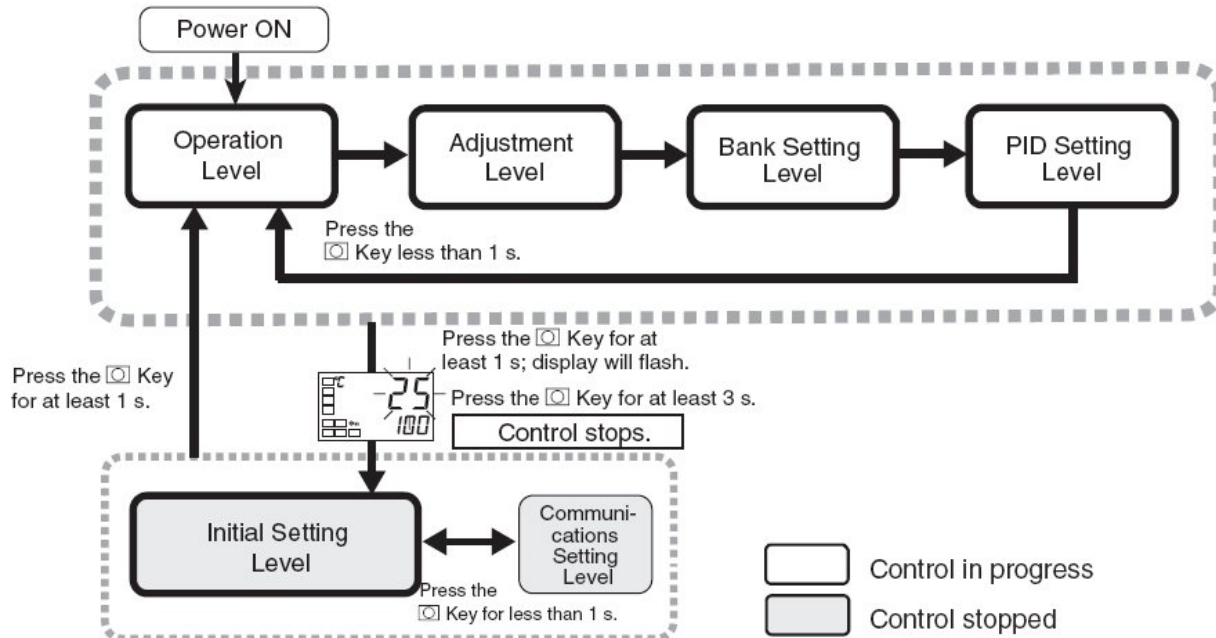

Figure 24: Omron E5CN-H Menu Navigation

OPERATIONS (Continued):

Mode Parameter Settings (E5CN-H):

The Omron E5CN-H temperature controller has been programmed prior to shipment, so no additional programming is normally necessary. The table below shows the various controller settings for this unit when properly configured to operate the TYTAN inline heater. Some internal menus have been factory programmed and subsequently locked. Those menus are not listed.

Level	Parameter	Description	Setting
Operations Level	R-S	Run – Stop selection	RUN
	AL-1	Alarm value 1	120°C
	AL-2	Alarm value 2	110°C
Adjustment Level	LAdJ	Adjustment level	
	At	Autotune execute	OFF
	INS	Temperature input shift	0.0*
	P	Proportion band	8**
	I	Integral time	233**
	D	Derived time	40**
	SPRt	SP ramp set value	OFF
	OL-H	MV upper limit	100.0
	OL-L	MV lower limit	0.0

* Value may differ per calibration requirements

** The P, I and D values may change following the execution of Auto-tune.

Table 8: Omron E5CN-H Parameters

Changing Primary Set Point (E5CN-H):

1. The process Set Point can be changed in the normal display mode.
2. Press the up and down arrow keys to select the desired setting.



After changing the process set point (SP-0) on the Omron controller, you must manually adjust the SP2 setting on the Future Design *over-temperature control*. See OPERATIONS Over-Temperature Controller FDC-L91 section.

OPERATIONS (Continued):

High Alarm (E5CN-H):

The Omron E5CN-H temperature controller incorporates an independent high-temperature alarm. Alarm 1 (SUB1) prevents heater operation above a preset maximum temperature that may harm the process and potentially the tank material. If the process temperature exceeds the preset high alarm value, the heater will be disengaged and the audibly alarm will sound. The temperature controller will activate once the process temperature exceeds the set point by the preset value. The factory setting of this alarm temperature is 248°F (120°C).

The high alarm value can be adjusted to a lower setting through the operations level.

1. Press the mode key  to enter the operations level.
2. Press the mode key  to index through the operations level to the SUB1 setting.
3. Press the up or down key to adjust SUB1 to the desired setting.
4. Press the mode key  to index through the operations level to the SUB2 setting.
5. The SUB2 setting is normally set at 10°C below SUB1. Press the up and down keys to adjust SUB2 to the desired setting.
6. Press and hold the level key for a minimum of three seconds to return to the normal display.

PID Tuning (E5CN-H):

The Omron E5CN-H temperature controller incorporates the capability of automatically tuning the PID parameters (Auto-Tuning) to fit the characteristics of the process. The optimum PID parameters are automatically set by forcibly changing the Manipulated Variable (MV) to calculate the characteristics (limit cycle method) of the control target. When the auto tuning is complete, the appropriate PID tuning parameters will be automatically installed into the non-volatile memory of the temperature controller.

1. Turn on water supply and set the desired water flow.
2. Set the Process Temperature Set point to the desired value (See **OPERATIONS; Changing Primary Set point**).
3. Press and hold the level key for a minimum of one second to enter the adjustment level.
4. Press the mode key to index through the adjustment level to get to the **At** setting.
5. Press the up or down arrow key to adjust the value to **At-2**.
6. Press and release the level key to return to the normal display. Verify that the display blinks.
7. Turn the ENABLE HEATER switch past the ON position to the RESET position, then release the switch, which will move to the ON position. If all criteria for the various safety devices have been met, the heater will begin to heat.
8. When the process is complete, the appropriate PID tuning parameters will be installed and retained in the non-volatile memory.

OPERATIONS (Continued):

Over-Temperature Controller (FDC-L91):

1. This over-temperature controller is located inside the electrical portion of the Tytan heater. It uses a separate temperature sensor to monitor the temperature on the surface of the heating elements.
2. This controller has two discreet set points:
 - SP2:** This is the over-temperature cutoff setting, which is set for 18°F (10°C) ABOVE the primary set point on the Process temperature controller.
 - HSP1:** This is an element high-temperature alarm setting, which is factory set at 248°F (120°C). Do not adjust this setting.

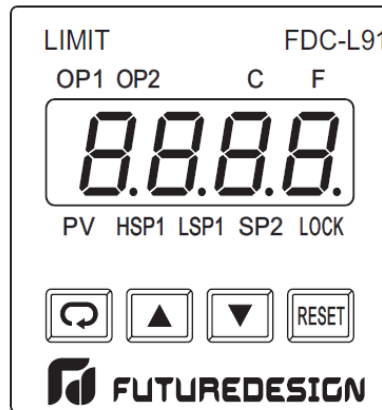





Figure 25: Futuredesign Over Temperature Controller

Display Features (FDC-L91):

Scroll Key : Used to 1) Select a setpoint to be displayed, 2) Select a parameter to be viewed or adjusted and 3) Advance display from a parameter code to the next parameter code.

Enter Key : Press for 4 seconds to enter the setup menu, or press for 8 seconds to enter the calibration mode.

Up Key : Used to increase the selected parameter value.

Down Key : Used to decrease the selected parameter value.

Reset Key : Used to 1) Reset the limit condition after the process is within the limit, 2) Revert the display to the normal display, 3) Reset the latching alarm and 4) Reset the limit annunciator.

OPERATIONS (Continued):

Operation Indicators (FDC-L91):

Op1:	Output 1 status indicator
OP2:	Output 2 status indicator
C:	Degree C indicator
F:	Degree F indicator
PV:	Process value
HSP1:	High limit set point 1
LSP1:	Low limit set point 1
SP2:	Set point 2 for output 2
LOCK:	Lock status indicator

Mode Parameter Settings (FDC-L91):

The Futuredesign FDC-L91 temperature controller has been programmed prior to shipment, so no programming will be necessary. The table below shows the various controller settings for this unit when properly configured to operate the TYTAN inline heater.

Parameter	Description	Default Setting
HSP1	Hi Limit Set Point	120 C / 248 F
LSP1	Low Limit Set Point	82 C / 180 F
SP2	Set Point 2 value, for Output 2	10 C / 18 F above "SP0" of the E5CN Temperature Controller
INPT	Input Type Selection	J_tC
UNIT	Process Unit	C / F
RESO	Display Resolution	NodP
IN.LO	Low Scale for Linear Input	0
IN.HI	High Scale for Linear Input	100 C / 212 F
SHIF	PV Shift (offset) Value	0
FILT	PV Filter Time Constant	2
OUT1	Output 1 Function	HI
O1.HY	Output Hysteresis Value	0.1
HSP.L	Lower Limit of HSP1	0
HSP.H	Upper Limit of HSP1	150 C / 302 F
LSP.L	Lower Limit of LSP1	0
LSP.H	Upper Limit of LSP1	120 C / 248 F
OUT2	Output 2 Function	ALA
ADDR	Address Assgnmnt of Digital Com	Not used
BAUD	Baud Rate of Digital Com	Not Used
PARI	Parity Bit of Digital Com	Not Used
AL.FN	Alarm Function	PYLA
AL.MD	Alarm Mode	Norm
AL.HY	Alarm Hysteresis	0.1
AL.FT	Alarm Failure Transfer	ON
EIFN	Event Input Function	0
DISP	Normal Display Format	PV

Table 9: Future Design FDC-L91 Parameters

OPERATIONS (Continued):



Programming (FDC-L91):

If and when the primary set point of the main process temperature controller is modified, the SP2 setting on the over-temperature controller FDC-L91 must be changed **manually**.

To Change the SP2 set point on the FDC-L91 over-temperature controller, follow the following procedure:

Do not change any of the other settings in this controller.

1. Turn the “Enable Heater” switch to the *Off* position. Leave the “Control Power” switch in the *On* position.
2. Open the door to the control-portion of the unit.

 ATTENTION	 CAUTION
Quand la porte de la boîte est ouverte, faites attention à ne pas toucher les composants électrifiés. Pour éviter un choc, du personnel qualifié doit effectuer cette procédure.	When the enclosure door is open, be careful not to touch the electrified components inside. To avoid shock hazard, qualified personnel should only perform this procedure.

Note: If the “Lock” LED is lit on the face of the Over-temperature Controller, press the () key for 4 seconds to clear “lock” feature of the FDC-L91, enabling up / down key function.

3. Identify the over-temperature controller, tagged 1SLC.
4. Press the Index key () to advance through the menu until “SP2” is highlighted.
5. Using the up and down arrow keys, adjust the SP2 value until it is 18°F (10°C) higher than the set point on the temperature controller.

Note: Do not change any other settings on this controller.

6. Close the door to the control portion of the enclosure.

OPERATIONS (Continued):

System Start-Up:

- 1) Turn on water at its supply source. Allow water to flow for several minutes to insure that all entrapped air has been purged from the heating column(s).
- 2) Stop water flow at point of use location and check all plumbing connections and water heater for leaks. Repair any water leaks if applicable.
- 3) Enable the power at the MAIN SERVICE DISCONNECT (provided by customer).
- 4) Ensure that the disconnect handle on the front of the unit (if provided) is ON and the EMO button on the front panel is not depressed.
- 5) Press the green ON button on the CONTROL POWER switch. At this time the temperature controller and all optional displays will come on.

<p>Note: Temperature controller set point should be set to "0" at this time to prevent accidental heater engagement during calibration procedures. Reference temperature controller section if required.</p>

- 6) Adjust the setpoint of the temperature controller to the desired value.
- 7) Turn the ENABLE HEATER switch past the ON position to the RESET position, then release the switch, which will move to the ON position. If all criteria for the various safety devices have been met, the heater will begin to heat.

System Shut-Down:

- 1) Turn the ENABLE HEATER switch from the ON position to the OFF position. Continue water flow through the heater until the outlet temperature display indicates 95°F (35°C) or less.
- 2) Press the red OFF button on the CONTROL POWER switch.
- 3) Turn off the MAIN SERVICE DISCONNECT to the unit (provided by customer).
- 4) Stop water flow through the unit. If the shut down will be for an extended period, open the customer supplied drain located near the inlet plumbing connection to drain the water from the unit. Once the unit is drained, dry the unit by blowing inert gas (N2 or CDA) through the piping system.

SPARE PARTS:

Listed below is the spare parts list for the Tytan water heater. These are items that may need replacement after some time in service, or may be damaged by accidental impact. This is not a complete parts list. Please contact PROCESS TECHNOLOGY if a more complete parts list is needed.

Recommendations:

One complete spare parts kit is sufficient for every 4 to 6 Tytan water heaters installed in a single location. Be sure to immediately reorder any parts that are used.

Spare Parts List Common to all Units:

Process Technology Part #	Description	Qty
3947	FUSE: 10A, 600V	3
4519	FUSE, 5A, 600V, MIDGET	1
9289	FAN: Cabinet Cooling Fan, 24 VDC	1
4851	Alarm, Sonalert audible buzzer	1
10941	SWITCH, selector, 3-position	1
10952	SWITCH, momentary, red-green pushbuttons	
10939	EMO SWITCH ASSEMBLY (pushbutton, light, base, contact block)	1
7383	RELAY: SSR, 15Amps, 50VDC	1
8986	RELAY: SSR Module, 125Amps, 600VAC (One per heating column 24-52kW (heat sink, two SSRs, overtemp thermostat, cooling fan, guard)	1
6147	GASKET, EPDM, mini sanitary flange	4
6847	PRESSURE RELIEF VALVE	1
6484	FITTING, compression, 1/8" x 1/4" NPT, for process sensor	1

Additional Spare Parts for Specific Models:

Process Technology Part #	Part for the Following Wattage Units:	Description	Qty
**		FUSE: high voltage power distribution (Refer to page 1 of the electrical prints for the specific part number of these fuses.)	3
TYE-**		HEATER: replacement heating column (Refer to label on heating column for the specific model number of this part)	1
TC-6	Wall-mounted models	SENSOR: heating column water temperature, J-type thermocouple	1
TC-10	Freestanding models	SENSOR: heating column water temperature, J-type thermocouple	1

MAINTENANCE:

The Tytan water heater requires only a routine inspection every 6 months to check the operation of the various operation and safety devices. Many of these devices require the control system to remain operational during inspection, while others may be checked while the unit is completely powered down.

Note: Several maintenance tasks can be completed simultaneously while the cabinet access covers are open and lockout/tagout procedures are in place.

The maintenance procedures for this unit must be performed by qualified technicians.

Normal maintenance of the Tytan water heaters consist of the following:

- 1) Disinfect the water heater along with the rest of the plumbing system on a regular basis if continuous sanitizing such as ozone injection is not employed.
- 2) Inspect the temperature sensors every 24 months, replace as needed.
- 3) Replace the heater control relays and fan after approximately 24-30 months of use. Actual life expectancy varies with application conditions such as hours of operation; control tuning parameters, applied voltage and amperage.
- 4) The Solid State Relay fan should be replaced and the heat sink is to be cleaned every 24 months.

TROUBLESHOOTING:

Condition	What to check	Action Required
<p align="center">General Heater Alarm / Heater will not engage / Main load contactor will not engage</p>	1. Future Design Overtemp limit controller	1. Verify that the thermocouple is in good working condition. Replace as needed. Consult the factory for the appropriate replacement component. 2. Verify that the controller is not locked into an alarm by performing a reset cycle on it. 3. Make sure the controller's alarm settings are appropriate for the current process.
	2. Heater TCO	1. Locate the Heater TCO terminal connections, referencing the supplied electrical schematic. Using an ohmmeter, verify continuity through the TCO (less than 0.4 ohms). Replace as needed. Consult the factory for the appropriate replacement component.
	3. SSR Heatsink TCO	1. Locate the SSR TCO, situated in the center of the heatsink, between the SSRs. Using an ohmmeter, verify the continuity through the TCO (less than 0.4 ohms). Replace as needed. Consult the factory for the appropriate replacement component.
		2. Verify the operation of the fan located on the bottom of the heat sink. Replace as needed. Consult the factory for the appropriate replacement component.
	4. OMRON Temperature controller alarm.	1. Verify that the thermocouple is in good working condition. Replace as needed. Consult the factory for the appropriate replacement component.
		2. Make sure that the controller's alarm settings are appropriate for the current process.
	5. Ground Fault alarm	1. Using an ohmmeter, measure each heater's power leads to earth ground and look for a shorted circuit. If a short to ground is identified within a column, it must be replaced. Consult the factory for the appropriate replacement component.
		2. Check the flashing sequence of the LED light on the GFCI module. The flashing sequence will indicate whether there is an actual Ground Fault problem. The LED sequence can be verified against a label on the GFCI component. Replace as needed. Consult the factory for the appropriate replacement component.
6. Verify any customer interface connections that may apply.	1. Verify the customer interface is being used properly, per the electrical drawings that are supplied with your Tytan water heater.	
<p>TYTAN water heater will not power up</p>	1. Verify the incoming voltage is present on the TYTAN water heater.	1. Make sure that incoming facility voltage is active to the TYTAN water heater. 2. Verify it also meets the requirement of the water heater design. This requirement can be located on the identification label located on the front door of the TYTAN water heater.
	2. Verify incoming power is on to the step down power supply and fusing located in the TYTAN water heater.	1. If Voltage is present on the incoming portion of the power supply, yet there is no output voltage, replace as needed. Consult the factory for the appropriate replacement component.
		2. If the low voltage fusing is shown to have activated, replace as needed. Consult the factory for the appropriate replacement component.

TROUBLESHOOTING (Continued):

Condition	What to check	Action Required
Circuit Breaker will not engage	1. Verify to see if the circuit breaker is in a tripped position and cannot be reset.	1. Try to reset the circuit breaker by turning the handle counter-clockwise, then attempt to turn the circuit breaker to the on position.
		2. If it cannot be reset, check the Tytan's main power circuit for a direct short-circuit to ground. If no short-circuit is found, replace the circuit breaker as needed. Consult the factory for the appropriate replacement component.
Temperature Stability issues	1. Temperature is overshooting setpoint	1. Verify that the water flow has not turned off ,or that it is being reduced during normal process flow cycle.
		2. Check the PID values in the OMRON controller. Perform auto-tune process as needed.
		3. Check the settings in both controllers, and verify their output relays are not failed forward (in a permanently closed state).
	4. Check that the SSRs are not failed forward (in a permanently closed state).	
2. Tytan cannot reach setpoint	1. Verify that the flow has not increased from the normal process cycle levels.	
	2. Verify the heater fuses are operating properly. An activated fuse will not allow the full wattage capacity of the heaters to be used, and will reduce the performance of the TYTAN water heater. Replace as needed. Consult the factory for the appropriate replacement component.	
Leak in the Column section of the cabinet	1. Thermocouple fitting leak	1. Tighten the fitting to stop the leak, or replace as needed. Consult the factory for the appropriate replacement component.
	2. Column manifold plumbing leak	1. Tighten up the sanitary flange connections. Inspect gasket seal for any damage. Replace as needed. Consult the factory for the appropriate replacement component.
	3. Column is leaking	1. The column must be replaced. Consult the factory with the current serial number and model number to order a replacement column.
Display of the OMRON controller is showing an error message.	1. (S.Err) Describes a thermocouple sensor error	1. Possible Thermocouple error problem. Replace as needed. Consult the factory for the appropriate replacement component.
Display on the Future Design overtemp device is showing an error message on the screen.	1. (Senb) Describes a thermocouple sensor error	1. Possible Thermocouple error problem. Replace as needed. Consult the factory for the appropriate replacement component.

WARRANTY:

All PROCESS TECHNOLOGY equipment, heaters and controls have been carefully inspected before shipping and are warranted to be free from defects in workmanship and materials for a period of one year from date of purchase on a pro-rated basis. At its option, PROCESS TECHNOLOGY will repair or replace any defects that are exhibited under proper and normal use. PROCESS TECHNOLOGY disclaims any responsibility for misuse, misapplication, negligence or improper installation of equipment, tampering or other operating conditions that are beyond its control (such as excessively high or low purge gas supply pressure). PROCESS TECHNOLOGY makes no warranty or representation regarding the fitness for use or the application of its products by the customer.

All products and components not manufactured by PROCESS TECHNOLOGY will carry the original manufacturer's warranty, copies of which are available upon request. PROCESS TECHNOLOGY makes no warranty or representation, expressed or implied, with respect to the products not manufactured by PROCESS TECHNOLOGY.

Products must be installed and maintained in accordance with PROCESS TECHNOLOGY instructions.

PROCESS TECHNOLOGY is not liable for labor costs incurred in removal, reinstallation, or unauthorized repair of the product or for damage of any type including incidental or consequential damage.

PROCESS TECHNOLOGY neither assumes nor authorizes any representative of PROCESS TECHNOLOGY or any other person to assume for it any other liabilities in connection with the sale of the products. This warranty may not be verbally changed or modified by any representative of PROCESS TECHNOLOGY.

Shipping Damages:

Claims against freight carriers for damage in transit must be filed by the customer at the time of delivery or as soon as possible.

Returns:

No product shall be returned to PROCESS TECHNOLOGY without first obtaining a return material authorization (RMA) number from a PROCESS TECHNOLOGY representative. All returns must be freight prepaid. Freight collect or shipments without authorization will be refused.

Information:

PROCESS TECHNOLOGY will endeavor to furnish such advice as it may be able to supply with reference to the use by buyer of any material purchased, but PROCESS TECHNOLOGY makes no guarantees and assumes no obligation or liability for advice given verbally or in print or the results obtained. Buyer assumes all risk and liability that may result from the use of any material, whether used by itself or in combination with other products. No suggestion for product use shall be construed as a recommendation for its use in infringement on any existing patent.

Conflict Between Documents:

Acceptance of this offer is expressly conditioned upon agreement to all terms and conditions contained herein. In the event of a conflict between the terms and conditions of purchaser's purchase order, and PROCESS TECHNOLOGY's terms and conditions, proposal or offer, the latter shall govern.

History of Revisions

Rev	Description of Revision	Date
00	Revision 00 is original release.	06/08/07
01	Updated parameter menus for E5CN, E5CK controllers, per ECN 07-015	11/16/07
02	Fixed RC3 and MA description errors.	03/27/09
03	Added "up to 480V" qualifier to UL/cUL standard (p. 6)	02/18/11
04	Added unpassivated and passivated SS options to model number explanation (page 12). Added –SB seismic bracket option information (page 18).	05/05/11
05	Removed the E5CK control section, and replaced with the E5CN-H. Added the E5EN-H.	06/07/12
06	Added Troubleshooting section (pages 51-53).	04/04/14
07	Revised seismic bracket installation instructions (page 18)	07/14/14
08	Clarified RI pin assignment (page 26)	02/09/15
09	Added bilingual warnings, reduced body-text size, added Omron E5CC and E5EC controls, other updates to startup/shutdown	10/07/15
10	Corrected RI outputs, pins 9-10, replaced open with closed. Revised TOC.	5/27/16
11	Changed minimum wattage to 9kW, per DCR 2108 (pages 5, 6, 11) Fixed figure 8 layout Added spare parts list, page 45	5/26/21

Approvals: _____

Product Manager	Date

Engineering	Date

Quality	Date
