

Frontier™ Series

Inline Solvent Heater



Installation Manual

Please supply your inline heater model and serial number when ordering spare parts or when requesting technical assistance.



www.processtechnology.com

7010 Lindsay Dr., Mentor, OH 44060 Phone: 440-974-1300 Fax: 440-974-9561 USA/CN: 800-621-1998

Table Of Contents

INTRODUCTION	2
PERFORMANCE DATA.....	4
HEATER SPECIFICATIONS.....	5
MODEL NUMBER.....	6
FACILITY REQUIREMENTS.....	9
SPACE-REQUIREMENTS.....	9
LOCATION.....	9
MOUNTING	10
PLUMBING-REQUIREMENTS	10
ELECTRICAL-REQUIREMENTS.....	11
INSTALLATION:	12
UNCRATING AND INSPECTION.....	12
COMPONENT IDENTIFICATION.....	12
PROCESS-FLUID-CONNECTIONS	13
ELECTRICAL CONNECTIONS.....	13
TEMPERATURE-SENSORS.....	14
ELEMENT-OVERTEMPERATURE-CONTROL	14
HEATER-ELEMENT-T.....	16
SAFETY FEATURES	17
OPERATION	18
CLEANING	18
START UP.....	18
SHUT-DOWN.....	19
DRAINING	19
MAINTENANCE.....	19
PREVENTATIVE MAINTENANCE	19
SERVICE.....	20
SERVICE.....	21
WARRANTY.....	22

INTRODUCTION:

The following symbols and warning labels may appear on the unit and/or in the instruction manual. The table below provides an explanation of each one.







PICTORAL DESCRIPTION	DESCRIPTION
	<p>DANGER indicates an imminently hazardous situation which, if not avoided, will result in death or serious injury. This signal word is to be limited to the most extreme situations.</p>
	<p>WARNING indicates a potentially hazardous situation which, if not avoided, could result in death or serious injury.</p>
	<p>CAUTION indicates a potentially hazardous situation which, if not avoided, may result in minor or moderate injury. It may also be used to alert against unsafe practices.</p>
	<p>DANGER: HAZARDOUS VOLTAGE ENCLOSED Voltage or current hazard sufficient to cause shock, burn or death. Disconnect and lock out power before servicing.</p>
	<p>WARNING: HAZARDOUS VOLTAGE Contact may cause electric shock or burn. This unit to be serviced by trained personnel only</p>
	<p>CAUTION: HOT SURFACE. DO NOT TOUCH Heater column may be hot. Allow unit to cool before servicing.</p>
	<p>PROTECTIVE EARTH (GROUND)</p>

Table 1: Frontier Warning Labels

Introduction (Continued):

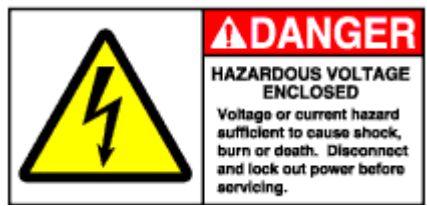
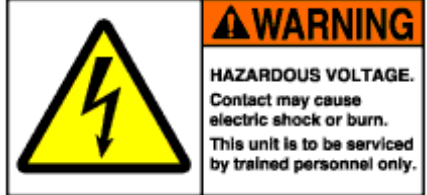
The Frontier™ heater by Process Technology is designed to safely heat process solvents through indirect contact instead of direct immersion. Wetted surfaces of the heater are constructed of electropolished 316L stainless steel, PFA and PTFE. The heater is a compact, completely welded, insulated, pressure resistant vessel. It is designed for use in either single pass or multi-pass (recirculating) flow applications.

The Frontier™ heater can withstand operation at a variety of temperature and pressure conditions. The maximum operating condition for the Frontier™ heater is 180°C at 100 PSI.

	Safe operation of this heater requires the use of over-temperature control sensors with an approved safety switching device. Operating in excess of the maximum operating temperature (180°C) can result in conditions that can cause harm to operators and equipment.
---	---

This Process Technology Frontier™ Heater consists of the following:

- * *Electropolished 316L stainless steel, PFA and PTFE fluid path*
- * *300-series stainless steel insulated housing*
- * *3 meters (10 feet) wire leads*
- * *(3) Element over-temperature sensors*
- * *(3) Thermal Cut-off Device (TCO) (internally wired in series)*
- * *Tube Stubs for fluid inlet and outlet connections*
- * *(2) stainless steel mounting brackets*

The following equipment is recommended for safe operation of the Frontier™ Heater, and must be customer-supplied.

- * *Process temperature controller*
- * *Liquid level sensor*
- * *Proper high-voltage power fusing and electrical disconnect switch*
- * *Pump motor safety interlock circuit*
- * *Ground fault circuit protection*

	The Process Technology Frontier™ heater heats process fluid to temperatures as high as 180°C. However, the over-temperature protection circuit will allow the heater core to reach temperatures as high as 288°C before TCO activation. Consult the factory BEFORE attempting to heat flammable or combustible fluids.
---	---

Introduction (Continued):

Performance Data:

The Frontier™ heater is designed to be used in either single pass or multi-pass (recirculating) flow applications. An application is defined as single pass when the solution will enter the heating chamber only once and must be heated to the desired temperature when it exits the heater. A multi-pass application is one in which the solution will be recirculated through the process and returned to the chamber heater, and may take several cycles through the heater to reach the desired temperature.

SINGLE PASS FLOW APPLICATION: For single pass applications, the Frontier™ heater is designed to provide a specified temperature increase at a given flow rate. Table 1 shows the maximum temperature increase (ΔT) that can be achieved for continuous flow conditions at heater powers from 3-36 kW. Note: values based on the specific heat/weight of water.

Flow (LPM)	Heater Power, kilowatts (kW)							Flow (GPM)
	3	6	9	12	18	24	36	
	Theoretical Maximum Temperature Rise (°C)							
10	4.3	8.6	12.9	17.1	25.7	34.3	51.4	2.6
15	2.9	5.7	8.6	11.4	17.1	22.9	34.3	4.0
20	2.1	4.3	6.4	8.6	12.9	17.1	25.7	5.3
25	1.7	3.4	5.1	6.9	10.3	13.7	20.6	6.6
30	1.4	2.9	4.3	5.7	8.6	11.4	17.1	7.9
35	1.2	2.4	3.7	4.9	7.3	9.8	14.7	9.2
40	1.1	2.1	3.2	4.3	6.4	8.6	12.9	10.6
45	1.0	1.9	2.9	3.8	5.7	7.6	11.4	11.9
50	0.9	1.7	2.6	3.4	5.1	6.9	10.3	13.2
55	0.8	1.6	2.3	3.1	4.7	6.2	9.4	14.5
60	0.7	1.4	2.1	2.9	4.3	5.7	8.6	15.9
65	0.7	1.3	2.0	2.6	4.0	5.3	7.9	17.2
70	0.6	1.2	1.8	2.4	3.7	4.9	7.3	18.5
75	0.6	1.1	1.7	2.3	3.4	4.6	6.9	19.8
80	0.5	1.1	1.6	2.1	3.2	4.3	6.4	21.1

Table 2: Maximum Temperature Increase as a Function of Power vs. Flow

MULTI-PASS FLOW APPLICATION: For a multi-pass application, the Frontier™ heater will elevate and maintain the temperature of a fixed volume of solution as it is circulated. Use the following formula to estimate the heat-up time for a volume of fluid in a multi-pass system. For estimating purposes, the specific heat and weight of water are often used. However, more accurate results will be achieved using the properties of the specific solution.

$$\text{Heat-up Time (minutes)} = \frac{\text{Volume (liters(L))} \times \text{Density (kg/L)} \times \text{Temperature rise (°C)} \times \text{Specific heat (J/kg x °C)}}{\text{Heater Power (kW)} \times 60,000}$$

This formula does not take into account any heat losses to the surrounding environment. Other factors that must be considered include heat losses through plumbing and exposed process tank surfaces, and the load placed on the heater by the introduction of cold products and chemicals into process tanks.

HEATER SPECIFICATIONS:

Product	Frontier™ Series Heater
Approvals	<p>CE, UL499, CSA C22.2. UL823, Rated for Class I, Division 2 hazardous locations.</p> <p>ATEX  II 3G Ex ic IIc T4 Gc Ta:-30°C to +60°C</p>
Wattage	3-36 kW - Refer to model number tree or facilities print for the wattage of a specific unit
Voltage	120 VAC – 600 VAC, 50/60Hz, single or three phase
Dimensions:	Refer to facilities print for specific heater dimensions
Wetted surfaces:	Electropolished 316L Stainless Steel, PFA and PTFE
Operating temperatures: Process inlet Process outlet	Up to process outlet temperature Up to 180°C (356°F)
Ambient Air Temperature	-30°C (-22°F) to 60°C (140°F)
Flow Rate Range	<p>“L” flow configuration: 8 lpm (2.1 gpm) to 30 lpm (8 gpm) “M” flow configuration: 20 lpm 5.3 gpm) to 80 lpm (21 gpm) “H” flow configuration: > 60 lpm (15.9 gpm) *</p> <p>*Note: Maximum flow rate is dependent on the available pressure and the pressure drop across a particular heater/configuration.</p>
Pressure Rating at 180°C	690 kPa (6.9 bar, 100 psi) Note: See fitting manufacturer information for pressure ratings of customer supplied fittings
Mounting Brackets	Stainless Steel, adjustable
Overtemperature Sensors	Qty (3) - Refer to model number tree or facilities print for details
Thermal Cut-Off Device	Qty (3) hermetically sealed bi-metallic switches, (wired in series)

Table 3: Frontier Specifications

MODEL NUMBER:

Process Technology model numbers are designed to offer some description of the heater construction, including features and options. The model number can be found on the model/serial number label located on the junction box located on the heater's electrical junction box.

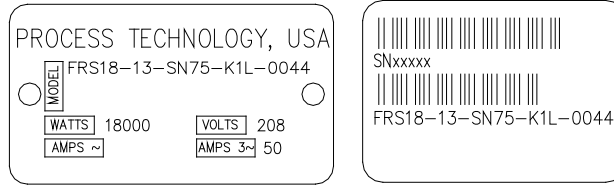

Figure 1: Model and Serial Number Labels

Model Number Explanation:

Provided below is an example of a typical model number along with an explanation of each part. This key will help you understand your model number.

Model number example:

FRS18-13-SN75-3K31L4-##

① ② ③④ ⑤ ⑥ ⑦ ⑧ ⑨ ⑩

① **Heater Series Type.** The model number will always begin with the series type of your heater.

② **Heater Wattage.** The first number(s) in the model number will always represent the kilowattage of your heater. The table provided below identifies the standard available wattage ratings of the Frontier™ heater.

Heater Model Number	Watts	Heater Model Number	Watts
3	3000	18	18000
6	6000	24	24000
9	9000	36	36000
12	12000		

Table 4: Wattage Rating

③ **Heater Voltage.** The next set of up to (2) numbers following the heater kilowattage will describe the rated voltage of the heater.

Heater Model Number	Rated Voltage (V)	Heater Model Number	Rated Voltage (V)
1	208	7	440
2	240	8	575
3	380	9	220
4	400	10	200
5	415	12	120
6	480	14	600

Table 5: Voltage Rating

Model Number Explanation (Continued):

- ④ **Voltage Supply Phase.** This character indicates if the required supply voltage is to be single phase or 3 phase.

Heater Model Number	Voltage Phase
1	Single phase
3	Three phase

Table 6: Voltage Supply Phase

- ⑤ **Process Inlet/Outlet Plumbing Connections.**

The characters used to describe the plumbing connections signify the type of connection and its size. The heater inlet and outlet plumbing connections are the same type and size. Please refer to the table below to see the specific plumbing connections provided with the heater:

Heater Model Number	Description
SN50	½-inch non-threaded tube stubs
SN75	¾-inch non-threaded tube stubs
SN100	1-inch non threaded tube stubs
V50	½-inch Swagelok VCR connections
V75	¾-inch Swagelok VCR connections
SF50	½"-inch sanitary flange
SF75	¾-inch sanitary flange
SF100	1-inch sanitary flange

Table 7: Inlet/Outlet Connections

- ⑥ **Element Over-temperature Quantity and Sensor Type.** Five different element over-temperature sensor types are available for the Process Technology Frontier™ heater. Please refer to the table below for a brief listing of the available options.

Heater Model Number	Quantity of Sensors	Heater Model Number	Sensor Type
1	1	K	K-Type TC
3	3	E	E-Type TC
		J	J-Type TC
		H	100-Ohm RTD (2-wire)
		R	1000-Ohm RTD (2-wire)

Table 8: Element Over-temperature Sensors

- ⑦ **Thermal Cut-Off (TCO) Quantity and Type.** Two different TCO temperature settings are available for the Process Technology Frontier™ heater. Please refer to the table below for a brief listing of the available options.

Heater Model Number	Quantity of Sensors	Heater Model Number	TCO Activation Temperature	Description
1	1	1	232°C	For applications between 90°-125°C
3	3	2	288°C	For applications between 125°-200°C

Table 9: Thermal Cut-Off (TCO) Devices

Model Number Explanation (Continued):

- ⑧ **Flow Configuration.** Several internal baffling configurations are available in order to maximize heat transfer. Please refer to the table below for a brief listing of the available options.

Heater Model Number	Description	Recommended Flow Range
L	Low Flow Range	8 - 30 lpm (2.1 – 8 gpm)
M	Medium Flow Range	20-80 lpm (5.3 – 21 gpm)
H	High Flow Range	60+ lpm (15.9 gpm)

Table 10: Flow Configuration

- ⑨ **Chamber Length.** Options and custom configurations identified using numerical and/or alphabetical characters.

Heater Model Number	Overall Length
1	Short: 32.0 cm (12.63 in.)
2	Medium: 46.0 cm (18.13 in.)
3	Long: 74.0 cm (29.13 in.)
4	Extra Long: 102.0 cm (40.13 in.)

Table 11: Chamber Length

- ⑩ **Options / OEM Configuration.** Options and custom configurations identified using numerical and/or alphabetical characters.

FACILITY REQUIREMENTS:

Before installing the Frontier™ heater confirm the facility requirements listed below.

Space Requirements: The Frontier™ heater is designed to be installed within a tool or bench near the process tank assembly. Allow adequate space in the tool for mounting of the heater. Also provide space to make necessary power and plumbing connections to the heater.

	The heater should be installed in an area free from excessive chemical or liquid exposure. The electrical junction area must not be submerged or exposed to excessive splashing or high pressure spray.
---	--

Location: The Frontier™ is designed to be located in areas where exposure to process chemistry is likely. The heater's external components are constructed of materials similar to the wetted components, but is not designed to be externally submerged.

NOTE: This equipment is suitable for Class I, Division 2, Groups A-D or non-hazardous locations only.

	EXPLOSION HAZARD – No replaceable components. Substitution of components may impair suitability for Class I, Division 2.
--	---

	Over-pressure protection should be installed to prevent pressures in excess of the maximum pressure at a specific temperature. Reference System Specifications or the heater's facilities print for additional information.
---	--

Facility Requirements (Continued):

Mounting: The Frontier™ heater is supplied with adjustable mounting brackets. Ensure that the mounting location will adequately support the weight of the chamber, its supporting hardware and plumbing, and the fluid in the system. When mounted, the process outlet must be above the process inlet.

	For products with a mass greater than 18kg (40 lbs.), use lifting aides and proper lifting techniques when moving.
---	---

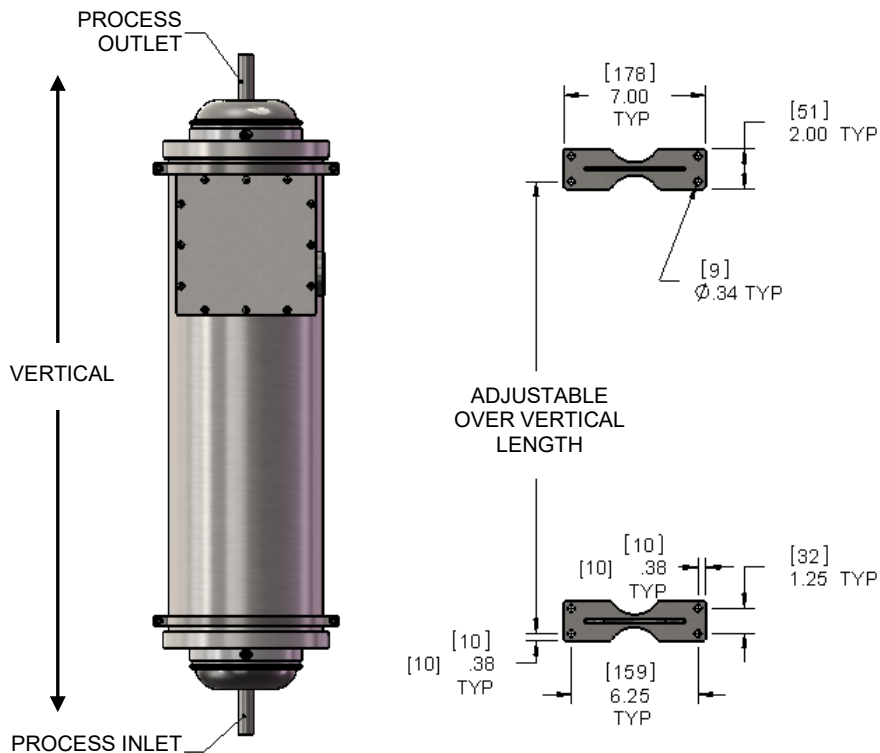

Figure 3: Mounting and Fitting Location

Plumbing Requirements:

The Frontier™ heater is supplied with stainless steel tube stubs for the fluid inlet and outlet connections. Refer to the fitting manufacturer's specifications and instructions for proper fitting selection and installation requirements.

	Fittings must be installed per the manufacturer's recommendations.
---	---

Plumbing must be compatible with process chemicals and temperatures. The inlet plumbing should also include a means to drain the unit for service.

FACILITY REQUIREMENTS (Continued):

Electrical Requirements:

Separate wires are provide for heater power and the various safety sensors. Reference the heater’s model number tag for the electrical power requirements of this heater. Verify that the electrical service is rated and fused for the required amperage draw.

Electrical disconnect devices and over-current protection must be selected in accordance with IEC-60364-4.

Ensure protective measures used for isolation and switching comply with IEC 60364-4.

Over-current Protection: If using circuit breakers, ensure use of a circuit breaker suitable for isolation and in compliance with IEC 60947-2. If using fuses, select in accordance with IEC 60269-2 combined with a magnetic contactor in accordance with IEC 60947-4-1.

Ensure protective measures for over-current in electrical wiring is in accordance with IEC 60364-4-43 and IEC 60364-4-473.

	Do not exceed the rated voltage. Irreparable damage to the heater will result.
---	---

NOTE: Ensure electrical power fusing and disconnects meet local jurisdictional requirements. Fuse ratings noted in this document are for reference only. Ensure external electrical components comply with local requirements before operating this unit.

INSTALLATION:

Before installation, carefully read this entire section.

	<ol style="list-style-type: none">1. NEVER exceed recommended temperature and pressure ratings.2. Turn power off at the main disconnect before performing any service.3. Lock and Tag the disconnect to prevent the equipment from accidentally being energized during servicing.4. Read all instructions carefully and understand equipment before operating. Consult factory for assistance if needed.
---	--

	<p>For products with a mass greater than 18kg (40 lbs.), use lifting aides and proper lifting techniques when moving.</p>
---	---

Uncrating and Inspection:

- 1) The Frontier™ heater may have been shipped in a horizontal or vertical position.
- 2) Remove the Heater assembly from its shipping container.
- 3) Remove box containing all support equipment.
- 4) Remove any protective packaging material and discard.
- 5) Inspect unit for any apparent physical damage.
- 6) Check component list for all parts.

Component Identification:

The Frontier™ heater includes the following items:

- 1) Heater Chamber Assembly: Consists of electropolished 316L stainless steel fluid path with an insulated stainless steel chamber.
- 2) Mounting Hardware (shipped loose): Mounting brackets are included and attach to the top and bottom of the heater chamber.

INSTALLATION (CONTINUED):

Process Fluid Inlet and Outlet Connections:

- 1) Remove the protective plastic caps from inlet and outlet connections of the heater chamber assembly.
- 2) Connect appropriate fittings to the Inlet and Outlet of the heater chamber assembly. Refer to the fitting manufacturer's specifications and instructions for proper fitting selection and installation requirements.



Use care not to damage the surface of the inlet/outlet tube stubs. Damage may prevent the fittings from properly sealing, which may lead to a potential leak.

Electrical Connections:

Main Power:

Power leads on the Frontier™ heater consist of (3) three black power leads, and (1) one green ground lead. Conduit and all ancillary electrical connection requirements are to be supplied by the end user. All electrical connections and safety devices must comply with local electrical code guidelines.

- 1) Refer to the model number label for the power requirements for this heater.
- 2) Fuse the incoming power supply lines for the rated amperage using an approved electrical disconnect. The electrical disconnect must meet the following minimum requirements:
 - Appropriate voltage and amperage ratings for the specific heating system. Verify that all fused electrical disconnects meet jurisdictional requirements.
 - For safety of service and maintenance personnel, this electrical disconnect must be located within sight of the equipment.
- 3) Ensure that all services are off before making connections (electrical, liquids, and gas). Lockout and Tagout as appropriate. Use only approved and properly rated wire, conduit and connectors.



Use only approved and properly rated wire, conduit and connectors.

- 4) Connect heater leads to an electrical disconnect device in the customer supplied controller. This electrical disconnect must have the proper electrical rating necessary for the equipment.
- 5) Connect heater ground lead to proper grounding point.



Check all connections before applying power.

INSTALLATION (CONTINUED):

Temperature Sensors and over-temperature control:

The Frontier™ heater is supplied with redundant temperature monitoring capabilities to better ensure safe temperature levels. These sensors must be installed into a customer-supplied control package to protect the equipment from accidental damage and to ensure operator safety. Refer to the facilities print for the specific temperature sensors supplied with the heater. Devices Include:

- Element Over-temperature Control Device
- Heater Element TCO (Thermal Cutoff) Device

NOTE: Failure to use the supplied over-temperature control devices for their intended purposes may void all or part of the equipment warranty. Consult factory for technical assistance.

Element Over-temperature Control Device:

The Heater Over-temperature Control Device measures the operating temperature of the heating element. This heater is supplied with three sensor for element temperature sensing. The sensors are positioned so that each electrical phase is monitored. Should an electrical phase loss occur and two sections of the heater reduce or produce no heat output, the other sensors will still detect any over-temperature condition.



These sensors MUST be connected to an ELV circuit(s).

These sensors MUST be connected to an approved safety switching device.

Activation of the over-temperature protection should require manual reset to enable heating.

These sensors are in direct physical contact with the metallic heating element sheath and consequently in contact with protective earth/ground.

NOTE: If providing phase loss detection as part of the main power control, then it may not be necessary to monitor all 3 sensors. Refer to local jurisdictional code requirements to ensure safe operation of the heater.

INSTALLATION (CONTINUED):

Element Over-temperature Control Device (continued):

The Frontier™ heating elements operate at a higher temperature than the process solution. The element over-temperature control device(s) measure(s) the temperature of the heating elements and should interrupt the power to the heater if excessive element temperature is detected.



Due to the heater's internal flow baffling configuration, there will be some temperature variation between the three element over-temperature sensors. If only relying on one sensor for overtemperature control, it is very important to monitor the sensor labeled TC1.

The element operating temperatures will vary based on variables such as the flow rate and the heaters flow configuration. As such, set the respective element over-temperature control 15°C above the maximum normal element operating temperature.

NOTE: If nuisance tripping of the over-temperature control is experienced, increase the control setting in 5°C increments until normal operation is achieved.

INSTALLATION (CONTINUED):

Heater Element TCO (Thermal Cutoff):

The Heater Element TCO is a bimetallic switch that opens when it reaches a preset temperature. This is a resettable device which must be connected to interrupt the operation of the control circuit if it is activated by an element over-temperature condition.

This heater is supplied with Three internal TCO devices (wired in series), which must be wired to the control's safety circuit. The TCOs are positioned so that each electrical phase is monitored. Should an electrical phase loss occur and only 1/3 of the heater produce full power, one of the three TCOs will still detect any over-temperature condition.



Do not connect the TCO in series with the heating element/main load. The TCO is designed to be wired into the heater's control circuit, connected in series with the coil of the magnetic contactor for the main load.

Protection of the circuit shall be done with a fuse, according to IEC or EN 60691 or a circuit breaker according to IEC 60947-2.

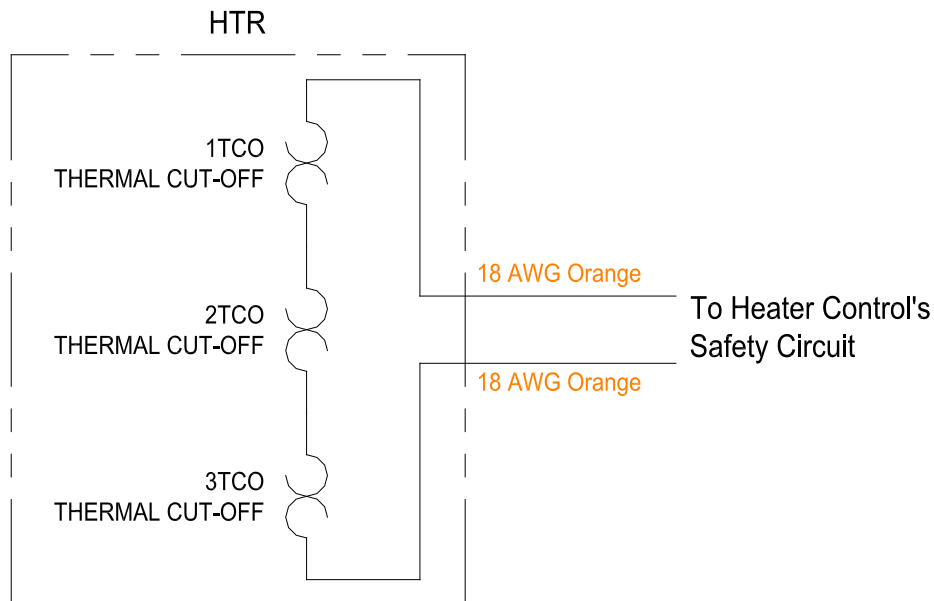

Figure 5: TCO Circuit

SAFETY FEATURES:

Safety System Network:

This Frontier™ heater is supplied without a Temperature Control package. Certain safety interlocks must be incorporated into the control package to prevent damage to the heater and ensure the safety of the operator. Each interlock circuit monitors a critical operating parameter of the heater. The control system is designed so that if a "fault condition" is detected by one of the sensors, the power to the heating element is disengaged. The shutdown mechanism may be momentary or latching; refer to table below.

Safety device	Operation	Type of Shutdown
Pump Interlock	Monitors condition of pump, disrupts power to heater when pump is not in operation.	latching
Liquid Level Control	Monitors presence of adequate fluid in heater vessel, disrupts power to heater if fluid is not present in the outlet piping.	latching
Process Temperature Control Device	Monitors temperature of fluid, disrupts power to heater when temperature rises above setpoint.	momentary
Process Over-Temperature Control Device	Monitors temperature of fluid, disrupts power to heater when temperature rises above setpoint.	momentary
Heater Element Over-Temperature Control Device	Monitors temperature of heating element, disrupts power to heater when temperature rises above setpoint. (Refer to chart 1).	latching
Heater Element TCO	Monitors temperature of heating element, disrupts power to heater when temperature rises above melt point of TCO.	latching

Table 12: Safety System Network

OPERATION:

Cleaning:

This Process Technology Frontier™ heater was cleaned before shipment. However, cleaning is typically required to remove any contaminants remaining after installation. The times required for cleaning of the system are dependent on DI water quality, flow rates, and installation techniques, and will vary. Additional steps may be indicated for some applications.

- 1) Operate the Frontier™ heater at ambient temperature for several hours, overnight if possible, at a minimum flow rate of 2 lpm (0.5 gpm).



Do not exceed drain temperature and pressure ratings.

- 2) Operate the Frontier™ heater for several hours, overnight if possible, at the maximum DI Water flow rate that will allow an exit temperature at or above 70°C to be maintained.

NOTE: Components of the heater are constructed of electropolished 316L Stainless Steel, PFA and PTFE. Verify chemical compatibility before sanitizing the unit.

- 3) Sanitize heater and plumbing.



During operation, the surface temperature of the heater may exceed 90°C. Avoid contact - serious personal injury may result.

Start Up Procedure:

- 1) Start process fluid flow. Allow solution to flow for several minutes to remove any air from the heating chamber.
- 2) Turn on the main power to the system.
- 3) Turn on the control module.
- 4) Verify proper reading of the process temperature.
- 5) Engage the control system's safety relay, if applicable.
- 6) Turn on the heater.

OPERATION (CONTINUED):

Shut-Down Procedure:

	<p>The heater chamber may contain process solution or residue. This material should be handled with the same care and precautions as any process solution.</p>
---	--

- 1) Turn off electrical power to the heater.
- 2) Allow heater to cool. The heater may be damaged if the heater is allowed to operate in air or if residual heat is not allowed to dissipate before draining. Before the chamber is drained, the outlet temperature must be allowed to cool to within 1°C of the inlet temperature. Then, wait an additional 10 minutes.
- 3) Turn OFF process fluid flow through the heater.
- 4) Turn OFF process controller.
- 5) Turn OFF Main Electrical Power.
- 6) For extended shut down periods, drain the system.

Draining Procedure:

Open the drain valve and allow any solution in the chamber to drain from the unit. For proper draining, ensure that the outlet plumbing is NOT obstructed to allow proper “venting” to the chamber.

	<p>Small amounts of process chemistry may remain in the unit after draining. The unit should be flushed with hot water then drained several times to eliminate any residual chemistry.</p>
---	--

Maintenance:

Preventative Maintenance of the Heater Chamber:

The Process Technology Frontier™ heater requires minimal preventive maintenance.

The process inlet/outlet fittings should be checked for leaks every Six Months or at the interval recommended by the fitting manufacturer – whichever comes first.

SERVICE:

Process Technology supports its product line with a strong technical support and field service program. If your Frontier™ heater fails to perform properly, follow the outlined steps for resolution.



There are no user serviceable or replaceable parts inside the heater. Do not attempt any field repairs as this will void the warranty.

- 1) Verify connections and program parameters.
- 2) Contact the Process Technology Technical Service Group. When placing this call, please have available the model number and serial number of the unit (located on the system tag), information about the application of the equipment, and information regarding the chemical constituents of the process fluid. The Service Technician will evaluate the situation and determine a course of action for troubleshooting and repair.
- 3) If the Technician determines that the unit should be returned to the factory for evaluation, a Returned Materials Authorization (RMA) Number will be issued. A return will not be accepted without prior authorization.

To protect the safety of Process Technology's workers and any others that may come in contact with the Frontier™ heater in the course of transport, evaluation, and repair, Process Technology requires that these practices be followed in returning the equipment to the factory:

- 1) Rinse the equipment until it is free of any chemical residuals. This is required for safe transport and handling of the equipment.
- 2) Wrap the unit in plastic and secure. Make sure that it does not leak. (Process Technology is not responsible for damage caused by leakage during shipping.)
- 3) Carefully package the unit for shipment.
- 4) Indicate the type of chemical that was in use at the time of failure. Include this information on the packing slip or place the information on the outside of the box. Process Technology will not risk exposure of its personnel to unknown chemicals. A return will not be evaluated until chemical information is received.

NOTE: Because of the configuration of the heating coils within the unit, it is possible that process fluid residues may remain even after thorough rinsing. Chemical information must be included even when a unit is believed to be clean so that Process Technology may protect its workers from exposure to these residues.

- 5) Clearly mark the outside of the box with the RMA number.
- 6) Ship the component prepaid to Process Technology.

SERVICE (CONTINUED):

Upon receipt of a returned unit, Process Technology will follow these steps:

- 1) The equipment will be carefully unpacked, inspected and cleaned, and an evaluation will be done.
- 2) A Process Technology technician will contact you with information regarding the scope of work to be performed, the cost, and the amount of time needed.
- 3) After a purchase order and authorization to perform the repair are received, the repairs will be completed and the unit returned.

WARRANTY:

All PROCESS TECHNOLOGY equipment, heaters and controls have been carefully inspected before shipping and are warranted to be free from defects in workmanship and materials for a period of one year from date of purchase on a pro-rated basis. At its option, PROCESS TECHNOLOGY will repair or replace any defects that are exhibited under proper and normal use. PROCESS TECHNOLOGY disclaims any responsibility for misuse, misapplication, negligence or improper installation of equipment, tempering or other operating conditions that are beyond its control (such as excessively high or low purge gas supply pressure). PROCESS TECHNOLOGY makes no warranty or representation regarding the fitness for use or the application of its products by the customer.

All products and components not manufactured by PROCESS TECHNOLOGY will carry the original manufacturer's warranty, copies of which are available upon request. PROCESS TECHNOLOGY makes no warranty or representation, expressed or implied, with respect to the products not manufactured by PROCESS TECHNOLOGY.

Products must be installed and maintained in accordance with PROCESS TECHNOLOGY instructions. PROCESS TECHNOLOGY is not liable for labor costs incurred in removal, reinstallation, or unauthorized repair of the product or for damage of any type including incidental or consequential damage.

PROCESS TECHNOLOGY neither assumes nor authorizes any representative of PROCESS TECHNOLOGY or any other person to assume for it any other liabilities in connection with the sale of the products. This warranty may not be verbally changed or modified by any representative of PROCESS TECHNOLOGY.

Shipping Damages:

Claims against freight carriers for damage in transit must be filed by the customer at the time of delivery or as soon as possible.

Returns:

No product shall be returned to PROCESS TECHNOLOGY without first obtaining a return material authorization (RMA) number from a PROCESS TECHNOLOGY representative. All returns must be freight prepaid. Freight collect or shipments without authorization will be refused.

Information:

PROCESS TECHNOLOGY will endeavor to furnish such advice as it may be able to supply with reference to the use by buyer of any material purchased, but PROCESS TECHNOLOGY makes no guarantees and assumes no obligation or liability for advice given verbally or in print or the results obtained. Buyer assumes all risk and liability that may result from the use of any material, whether used by itself or in combination with other products. No suggestion for product use shall be construed as a recommendation for its use in infringement on any existing patent.

Conflict Between Documents:

Acceptance of this offer is expressly conditioned upon agreement to all terms and conditions contained herein. In the event of a conflict between the terms and conditions of purchaser's purchase order, and PROCESS TECHNOLOGY's terms and conditions, proposal or offer, the latter shall govern.

History of Revisions

Rev	Description of Revision	Date
00	Revision 00 is original release.	05/07/14
-	Per DCR 583, revised multi-pass flow formula to indicate that heat-up time is in minutes, not hours.	02/08/16
01	Revised model number matrix on pages 6-8. Added directions for lifting and carrying to pages 9, 11; per DCR 870.	7/3/2018
02	Added Atex certification to page 6.	4/8/19
03	Revised Atex nomenclature, CE mark on page 5. Added J-Type overtemp sensor on page 7	8/20/19

Approvals: _____

Product Manager	Date
_____	_____
Engineering Manager	Date
_____	_____
Quality Assurance Manager	Date
_____	_____